

**Kwikset**

A Smarter  
Kind of  
Simple™



## Box Pack Price Book

March 2024

March 2024

**Kwikset**

**A: GENERAL INFORMATION**

Terms and Conditions	3
General Information	5
Functions	7
Weights and Measurements	14
Order Forms	17

**B: NEW PRODUCTS**

Perth	18
Sedona	20
Trafford	22
Hali Contemporary Interconnect	24

**C: KWIKSET SIGNATURE SERIES**

Handlesets	27
Levers	33
Knobs	36
Deadbolts	37
Specifications	39

**D: KWIKSET SECURITY SERIES**

Handlesets	43
Levers	
Knobs	45
Deadbolts	46
Combo Packs	46
Specifications	46

**E: ELECTRONIC LOCKS**

Halo	50
Smartcode	52
Home Connect	54
Specifications	56

**F: LIGHT COMMERCIAL**

Interconnect, Push Button Levers & Key Control	60
Specifications	64

**G: ACCESSORIES**

Pocket Door Locks	69
-------------------	----

**H: SERVICE PARTS**

Levers	71
Knobs	74
Deadbolts – Security Series	77
Deadbolts – Signature Series	81
Handlesets	84
Interconnect	87
Push Button Lever	89
Keys, Re-Keying Kits & Misc.	93
Electronic Service Parts	100
Style Abbreviations	103



## TERMS AND CONDITIONS OF SALE

Standard terms are 2% prompt payment discount for payment within 25 days from date of invoice; net 30 days from the date of invoice. Kwikset® reserves the right to charge and recover on invoices which are not paid within the above terms, a service charge of 1-1/2% a month for each month or fraction thereof during which the invoice remains unpaid, said service charge, however, not to exceed the highest applicable legal rate of interest. All orders, whether solicited or written by our sales representatives or forwarded by our customers are deemed to be mere offers to purchase in accordance with these Terms and Conditions of Sale until actually accepted by us at our home office in Lake Forest, CA. We reserve the right to refuse any order as well as the right to sell or not sell to any firm at our sole discretion. The acceptance of an order is expressly made conditional upon your assent to these Terms and Conditions of Sale. We object to the inclusion of any different or additional terms or conditions, even if the same are included in your order, a contract of sale will result upon the Terms and Conditions of Sale stated herein only. Prices reflected in this book apply to Wholesale customers only.

All sales are final.

### PRICES

Pricing based on full-case quantities only; orders for less than full case will be automatically adjusted up to the next full-case quantity. All prices are subject to change without notice and are not guaranteed. All taxes, duties or other charges are the responsibility of the customer.

### CLAIMS

Price claims must be submitted in writing to Kwikset, 19701 Da Vinci, Lake Forest, CA 92610 within 30 days from the date of invoice.

### CHANGES OR CANCELLATIONS

Beyond 5 working days of our acknowledgement date no changes can be made. Additions to an order will be handled as a separate order and must meet applicable minimum order requirements. Order cancellation on regular stock items only, or any portion thereof is allowed only upon prior written consent from Kwikset, and the payment of cancellation charges deemed appropriate.

### MINIMUM CHARGE

No order will be invoiced for less than \$100.00 net plus shipping charges except for lock accessory parts.

### MINIMUM ANNUAL SALES VOLUME

The company reserves the right to discontinue direct sales to any customer who does not meet the minimum annual sales volume requirement. The current annual requirement is \$50,000.00. Your annual purchases are determined by accepted, non-cancelled, and shipped orders received during each calendar year. Kwikset reserves the right to change any or all minimum annual sales volume requirements at any time. Any customer who does not meet the annual sales volume requirements may continue to purchase Kwikset products through a Kwikset distributor.

### RETURNS

Defective merchandise returned to our factories requires prior written authorization from a Kwikset Sales Rep or the Sales Office. A factory return authorization must accompany the returned shipment. The return authorization must include an itemized listing of the merchandise and an explanation stating the reason for return.

There will be a 20% product restocking fee on all returned merchandise.

### FREIGHT

All goods are invoiced FOB to our factory. Upon delivery of shipments to the carrier, title to, and the risk of loss or damage in transit for such shipments, passes to our customer. Kwikset's standard policy is to pay freight charges on all orders over \$1,000.00 net invoice value to a single destination in the continental U.S., by carrier and route of our choice. Shipments less than these quantities will not be shipped on a prepaid basis. If higher freight charges are incurred from customers specifying a carrier or route of their choice the additional cost will be added to that customer's invoice.

## DELIVERY CONDITIONS

Shipping schedules are our best estimates, and cannot be guaranteed. Kwikset is not responsible for any direct or consequential loss or damage resulting from an inability or delay in meeting shipping schedules.

## KWIKSET LIMITED WARRANTIES

Kwikset products are backed by one of the most comprehensive warranty programs available. You can feel confident that with the purchase of Kwikset you have selected the best quality product, backed by the best customer service available.

### MECHANICAL LIMITED WARRANTY

Except as otherwise provided below, Spectrum Brands, Inc., for its Kwikset® brand products ("Kwikset"), warrants to the original residential purchaser (the "Purchaser") that each Kwikset product (the "Product(s)" or "Kwikset Product(s)") will be free from mechanical defects under normal use from the date of purchase for as long as said Purchaser occupies the residential premises upon which the Product was originally installed ("Warranty Period"). This Mechanical Limited Warranty applies only to Products that were purchased from Kwikset or a Kwikset authorized seller, unless otherwise prohibited by law. Kwikset Products are legitimately sold only by authorized sellers who are required to follow Kwikset's policies, procedures, and quality control standards. Kwikset reserves the right to reject warranty claims from purchasers for Products purchased from unauthorized sellers, including unauthorized Internet sites.

### FINISH LIMITED WARRANTY

The finish on Kwikset Products is protected by a durable topcoat designed to maintain the beauty and quality of the Kwikset Product. Kwikset warrants to the Purchaser that the finish of the Product shall be free of defects in material and workmanship from tarnishing, flaking, and discoloring from the date of purchase for as long as said Purchaser occupies the residential premises upon which the Product was originally installed ("Warranty Period"). This Finish Limited Warranty applies only to Products that were purchased from Kwikset or a Kwikset authorized seller, unless otherwise prohibited by law. Kwikset Products are legitimately sold only by authorized sellers who are required to follow Kwikset's policies, procedures, and quality control standards. Kwikset reserves the right to reject warranty claims from purchasers for Products purchased from unauthorized sellers, including unauthorized Internet sites.

### ELECTRONIC LIMITED WARRANTY

Kwikset warrants to the Purchaser that Kwikset Products will be free from electronic defects under normal use for one (1) year from the date of purchase, as long as said Purchaser occupies the residential premises upon which the Product was originally installed ("Warranty Period"). This Electronic Limited Warranty applies only to Products that were purchased from Kwikset or a Kwikset authorized seller, unless otherwise prohibited by law. Kwikset Products are legitimately sold only by authorized sellers who are required to follow Kwikset's policies, procedures, and quality control standards. Kwikset reserves the right to reject warranty claims from purchasers for Products purchased from unauthorized sellers, including unauthorized Internet sites.

### EXCLUSIONS FROM WARRANTY

1. Any Kwikset Product produced prior to January 1, 2006.<sup>1</sup>
2. Any Kwikset Product which has been damaged as a result of installation contrary to any of Kwikset's written installation instructions is not covered by these warranties.
3. Any Kwikset Product which has been modified by any non-Kwikset component is not covered by these warranties.
4. Any Kwikset Product having a defect caused by neglect, misuse, abuse or unreasonable or extraordinary use or maintenance, including use in a commercial application, is not covered by these warranties.
5. Any Kwikset Product having a defect due to use of paints, solvents, or other chemicals is not covered by these warranties.
6. Any Kwikset Product that is used in combination with knobs, levers, or trim of other than those manufactured by Kwikset and designated for use with the applicable locks or latches is not covered by these warranties.
7. Any Kwikset Product that was purchased from an unauthorized seller is not covered by these warranties.

These warranties are not transferable. Therefore, no transferee is covered by these warranties.

<sup>1</sup>Kwikset Products produced prior to January 1, 2006, may be eligible for warranty in accordance with the terms and conditions of the applicable warranty program.

## WARRANTY CLAIMS

If you wish to make a warranty claim based upon a Product defect, please call us at 1-800-327-LOCK (5625) or contact us at [kwikset.com/support](http://kwikset.com/support).

Please note that you will be required to provide a description of any claimed defect(s) and a dated receipt or other proof of purchase from Kwikset or the Kwikset authorized seller, to verify warranty eligibility.

Certain claimed defect(s) covered by these warranties may be resolved by Kwikset providing you with troubleshooting steps.

Other claimed defect(s) covered by these warranties may require Product replacement. Products may not be returned to Kwikset without prior authorization from Kwikset. If authorized by Kwikset, you will need to mail your Product to:

Spectrum Brands, Inc.

ATTN: Kwikset Consumer Services

19701 Da Vinci

Lake Forest, CA 92610

A prepaid shipping label will be provided to you.

## REMEDIES

For certain claimed defect(s) covered by these warranties, as determined by Kwikset, Kwikset will provide you with troubleshooting steps.

For other claimed defect(s) covered by these warranties, as determined by Kwikset, Kwikset will replace the defective Product or part.

If a Kwikset Product, which is the same as the Kwikset Product or any part covered by these warranties, has been discontinued at the time of replacement or if Kwikset determines, in its sole discretion, that such replacement is inappropriate, Kwikset reserves the right to substitute an alternative product. Kwikset also reserves the right to accept or reject an alternative product proposed as a replacement, when the value is higher than that of the Product originally purchased by the Purchaser. Except as expressly provided in these warranties to the contrary, KWIKSET SHALL NOT BE OBLIGATED OR LIABLE FOR LABOR OR OTHER COSTS RELATED TO INSTALLATION, REPAIR OR REPLACEMENT OF A KWIKSET PRODUCT, OR FOR LOSS OF, OR DAMAGE TO ANY MATERIAL WHICH IS NOT SOLD BY KWIKSET.

## PATENT INDEMNITY

We agree to defend any suit or proceeding brought against our customer so far as based on claim that our products, or any part thereof, made solely to our specifications and furnished to our customer constitute an infringement of any U.S. patent, if notified promptly in writing and given authority, information and assistance at our expense for the defense of same, and we shall pay all damages and costs awarded therein against our customer. In case our products, or any part thereof, is in such suit held to constitute infringement and their use is enjoined, we will, at our expense and discretion, either procure for our customer the right to continue using the products or replace same with non-infringing products, or modify them so they become non-infringing, or remove such products and refund the purchase price (less depreciation, prorated from the purchase date). The foregoing states our entire liability for patent infringement by our products or any part thereof.

## INTELLECTUAL PROPERTY

No person or entity may sell, distribute, advertise, market or promote Kwikset branded products distributed by Kwikset Corporation ("Kwikset"), Spectrum Brands Hardware Home Improvement Division, without prior authorization from Kwikset. Customers of Kwikset who are authorized to sell Kwikset branded products are referred to herein as "Customers."

The Kwikset brand and all Kwikset trademarks, trade names, product depictions, colors, graphics or logos, whether or not registered or otherwise protected (the "Marks"), remain the sole and exclusive property of Kwikset and nothing arising out of the relationship between Kwikset and any Customer conveys to Customer any ownership rights in the Marks. Customer may use the Marks and then only in the sale or promotion of authentic Kwikset products in compliance with the terms of this policy. The Marks must be used exactly in the form provided and in conformity with all Kwikset trademark usage policies or guidelines, including, but not limited to, those relating to shape, color match and imprint quality. Any proposed deviation must be approved in writing by Kwikset prior to use. The Marks may not be used in or as part of any Customer domain name on the Internet. Prior to any use of the Marks on goods or services, Customer must submit samples for Kwikset's approval.

Additionally, no Customer may use product depictions, graphics, logos or text relating to Kwikset products that have not been provided by Kwikset in connection with the advertising, promotion or sale of Kwikset products without Kwikset's prior review and written approval of each such use. The Marks may not be used in or as part of any reseller or other third party (i) domain name or VRL on the Internet, (ii) trademark or service mark, or (iii) company or trade name. Any action on the part of a Customer that violates the terms of this policy or otherwise impairs the value of or goodwill associated with the Marks or is otherwise not in conformity with Kwikset's standards may result in the suspension or termination of the Customer's authorization or any other remedy permitted by law.

Kwikset grants to each of its Customers limited, non-transferable, non-sublicenseable licenses of the patents relating to the Kwikset products that the Customer is authorized to sell and of the copyrights in any packaging or other written materials included therewith or related thereto. Said patent and copyright licenses are solely to sell such Kwikset products covered by such patents and to which such copyrights relate only to end-users and other Customers in compliance with the terms of this document. The sale of such patented Kwikset products and the sale or use of such copyrighted materials by a Customer that violate the terms of this document exceed the scope of the licenses herein granted to the Customer and may constitute patent and/or copyright infringement.

## STANDARDS

Kwikset meets or exceeds the testing requirements specified for each product grade or rating.

- American National Standards Institute (ANSI)
- Builders Hardware Manufacturers Association (BHMA)
- Underwriters Laboratories, Inc. (UL)
- Americans with Disabilities Act (ADA)

## MISCELLANEOUS

Substitution of non-Kwikset components/parts, and any alteration or modification of factory parts, and other lock manufacturer's parts may result in door hardware which does not function properly or will fail and will void all warranties. Orders not specified with keying requirements will be shipped Keyed Differently (KD). Orders with keying requirements of K10 or more must have a "Letter of Release" on file with Kwikset stating that Kwikset Corporation will not be held liable for cost and expense arising from any loss or damage to property utilizing Kwikset products where 10 or more locks have been keyed alike. Contact your Sales Office account representative for a copy of the release form. Kwikset reserves the right to revise or modify products, product information, or pricing without notice. Product specifications and pricing reflect available information at the time of printing. Kwikset is not responsible for typographic or printing errors.

## LIMITATION OF LIABILITIES

**THERE ARE NO WARRANTIES WHICH EXTEND BEYOND THOSE STATED HEREIN. ANY IMPLIED WARRANTIES THAT MAY BE APPLICABLE TO PRODUCTS, INCLUDING IMPLIED WARRANTIES OF MERCHANTABILITY OR FITNESS FOR A PARTICULAR PURPOSE, ARE LIMITED IN DURATION TO THE DURATION OF THIS WARRANTY. SOME STATES DO NOT ALLOW LIMITATIONS ON HOW LONG AN IMPLIED WARRANTY LASTS, SO THE ABOVE LIMITATION MAY NOT APPLY TO YOU. UNDER NO CIRCUMSTANCES SHALL KWIKSET BE LIABLE FOR ANY SPECIAL, INCIDENTAL, OR CONSEQUENTIAL DAMAGES BASED UPON BREACH OF THIS LIMITED WARRANTY, BREACH OF CONTRACT, OR STRICT LIABILITY. SOME STATES DO NOT ALLOW THE EXCLUSION OR LIMITATION OF INCIDENTAL OR CONSEQUENTIAL DAMAGES, SO THE ABOVE LIMITATION OR EXCLUSION MAY NOT APPLY TO YOU. THIS WARRANTY GIVES YOU SPECIFIC LEGAL RIGHTS, AND YOU MAY ALSO HAVE OTHER RIGHTS WHICH VARY FROM STATE TO STATE.**

**Effective Date: [July 6th 2020]**

**ORDER CODE BREAKOUT**

Quantity	Specifies Quantity
Function & Style	Specifies Model and Function
Rose Design	Specifies Designer Rose
Handing	Handing Right or Left
Finish	Exterior/Interior
Keying	Special Keying
Code	Keying Code
Latch	Specifies Latch
Strike	Indicates Strike
Key Alike Qty	Keyed Alike

**Example:** “I would like to order 12 SmartKey Halifax levers, satin nickel finish, a round rose, 6-way adjustable latch and round corner strike.

Written as: 12-740HFL RDT 15 SMT 6AL RCS.

NOTE: All handlesets ordered LIP only.

**UNDERWRITERS LABORATORIES LISTED LOCKSETS**



To meet Underwriters Laboratories’ fire rating requirements UL listed locksets, UL listed latches, and UL listed strikes must be used together.

**AMERICAN WITH DISABILITIES ACT (ADA)**



Products displaying this symbol comply with the Americans with Disabilities Act of 1990.

**HOW TO ORDER 20MIN UL LOCKS**

FD = 20 minute UL designation

**Example:** “I would like to order 12 passage Halifax levers with a round rose, 6-way adjustable latch and round corner strike with 20 minute UL in Satin Nickel”

12-720HFL 15 RCALFD RCS.

**KEYING**

Code	Option	List Pricing Adder
KA	Keyed Alike (*SMT Only)	\$5.00
KD	Keyed Differently	N/A
K2, K3	Keyed Alike (2 Locksets, 3 Locksets)	N/A
MK	Master Keyed	\$15.00
PK	Builder (Protecto) Keyed	\$15.00
GMK	Grand Master Keyed	\$20.00
PMK	Builder (Protecto) Master Keyed	\$20.00
SMT	SmartKey Security	N/A

**BACKSET**

Backset is the distance from center edge of door to center of the 2-1/8" (54mm) diameter hole, 2-3/8" or 2-3/4" in most cases.

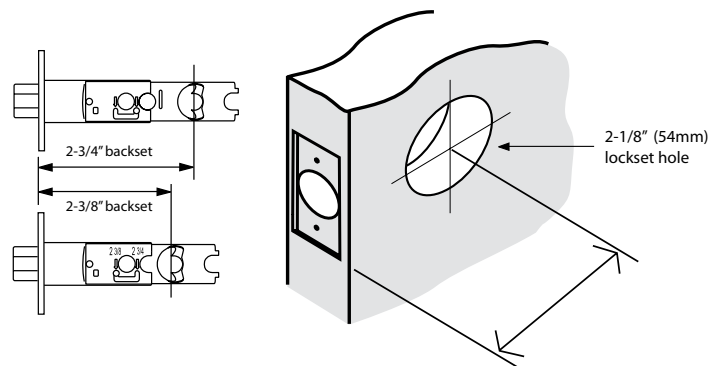

Model	Function
200/407/420/720/721/725	Passage/Hall/Closet
300/408/730/733	Privacy/Bed/Bath
334/335	Round Pocket Door Lock
400/438/740/756	Entry
405/409	Lever Keyed Entry
450/462/412/439/755/781	Storeroom/Vestibule
488/788	Half Dummy Trim, Surface Mounted
508	Interconnect
687/800/818	Single Cylinder Handleset
802/819	Dummy Handleset
898/814	Handle Only
899/815	Handle and Lever Only
599	Double Cylinder Gatelatch
158/258/660/780/782/980/982/817	Single Cylinder Deadbolts
159/665/785/985	Double Cylinder Deadbolts
912/916/620	Home Connect Deadbolt and Lever
240/250/260/270/917/955	Electronic Single Cylinder Deadbolt/Lever
942	Bluetooth Enabled Deadbolt
938/939/959	WiFi Enabled Deadbolt
966/968/971/973	Interior Pack for Handlesets

### HANDING

To determine the handing of a door face the OUTSIDE of the door. If the hinge is on the left side of the door, the door is left handed (LH). If the hinge is on the right side of the door, the door is right handed (RH).

**NOTE:** Handing required for dummy levers and interior packs with levers when lever design is not symmetric.

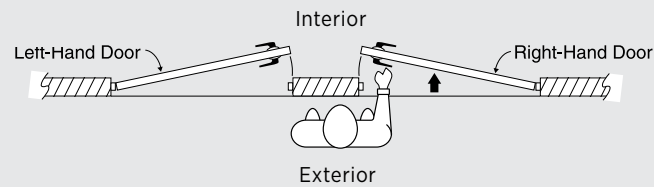



Finish	Description	ANSI/BHMA	Latch	Description
3	Polished Brass	605	RCAL	Round Corner Adjustable Latch
L03	Lifetime Polished Brass	605E	SCAL	Square Corner Adjustable Latch
5	Antique Brass	609	RFAL	Round Face Adjustable Latch
11P	Venetian Bronze	---	RCAL FD	Round Corner Adjustable 20 Minute UL
15	Satin Nickel	619	6AL	6-Way Adjustable Latch. Round front staked
26	Polished Chrome	625	6AL FD	6-Way Adjustable Latch 20 Minute UL
26D	Satin Chrome	626		
514	Matte Black	---		

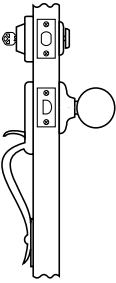
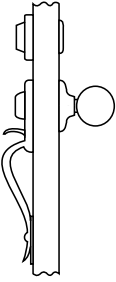

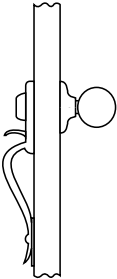
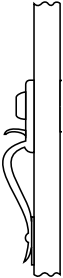
HANDLESETS	Function Name	Description	KWIKSET SECURITY SERIES w/ BHMA	KWIKSET SIGNATURE SERIES w/ BHMA
	<p>Handleset with Single Cylinder Deadbolt</p>	<p>Latch bolt operated by thumb piece outside and grip inside. Deadbolt operated by key outside and thumb turn inside.</p>	<p>687</p>	<p>800, 818</p>
	<p>Dummy Handleset with Dummy Deadbolt</p>	<p>Handle and grip act as a pull only. For inactive leaf of double doors. No operation.</p>	<p>N/A</p>	<p>802, 819</p>

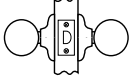
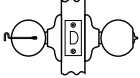
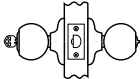
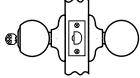
HANDLESETS	Function Name	Description	KWIKSET SECURITY SERIES w/ BHMA	KWIKSET SIGNATURE SERIES w/ BHMA
	Handleset with Knob or Lever	Latch bolt operated by thumb piece outside and grip inside.	898	815
	Handleset Only	Latch bolt operated by thumb piece outside	899	814



<b>KNOBS</b>	<b>Function Name</b>	<b>Description</b>	<b>KWIKSET SECURITY SERIES w/ BHMA</b>	<b>KWIKSET SIGNATURE SERIES w/ BHMA</b>
	Passage/Hall/Closet	Both knobs always free.	200 F75	720/725UL F75
	Privacy/Bed/Bath	Both knobs locked or unlocked by turn button inside. Outside knob unlocked by emergency key.	300 F76	730 F76
	Entry	Both knobs locked or unlocked by key outside or turn button inside.	400 F82	740/745UL F82
	Storeroom/Vestibule	Outside unlocked only while key is turned. Inside always free.	450 F86	750 F86
	Half Dummy Trim, Surface Mounted	For doors where only a pull is required. No operation.	488	788

NOTE: BHMA code in italics.

<b>LEVERS</b>	<b>Function Name</b>	<b>Description</b>	<b>KWIKSET SECURITY SERIES w/ BHMA</b>	<b>KWIKSET SIGNATURE SERIES w/ BHMA</b>
	Passage/Hall/Closet	Both levers always free.	200/407/420UL F75	720/725UL F75
	Privacy/Bed/Bath	Both levers locked or unlocked by turn button or push button inside. Outside lever unlocked by emergency key.	300/408ULL F76	730 F76
	Keyed Entry Lever	Both levers locked or unlocked by key outside or turn or push button inside.	405 F82	740/745/756UL F82
	Storeroom/Vestibule	Outside unlocked only while key is turned. Inside always free.	439/450/462/412UL F86	750/781 F86
	Half Dummy Trim, Surface Mounted	For doors where only a pull is required. No operation.	488	788

NOTE: BHMA code in italics.

<b>DEADBOLTS</b>	<b>Function Name</b>	<b>Description</b>	<b>KWIKSET SECURITY SERIES w/ BHMA</b>	<b>KWIKSET SIGNATURE SERIES w/ BHMA</b>
	Single Cylinder	Deadbolt operated by key outside and thumb turn inside.	660 E0153	980/982UL E0151 780/782UL 817UL E0152 158/258
	Double Cylinder	Deadbolt operated by key both sides.	665/E0143	985 E0141 785 E0142 159 E0152
	Thumb Turn Only	Deadbolt operated by thumb turn one side. No trim on exterior.	663 E0193	N/A

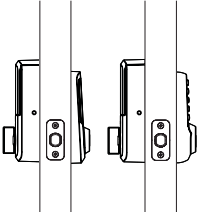
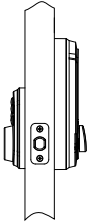
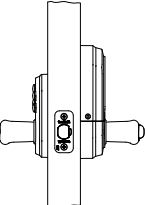
DEADBOLTS	Function Name	Description	KWIKSET SECURITY SERIES w/ BHMA	KWIKSET SIGNATURE SERIES w/ BHMA
	Conversion Kit	Converts 663 to 667 when door is bored through.	664	N/A
	Thumb Turn x Plate	Deadbolt operated by thumb turn on interior. Blank plate on exterior.	667 E01113	N/A
	Double Cylinder Gatelatch	Deadbolt operated by key outside and thumb turn inside.	599	N/A
ELECTRONIC DEADBOLTS	Function Name	Description	KWIKSET SECURITY SERIES w/ BHMA	KWIKSET SIGNATURE SERIES w/ BHMA
	Halo™	Deadbolt operated by key outside, electronic keypad or WiFi enabled device.	N/A	938/939/959 E0152
	Aura™	Deadbolt operated by key outside, electronic keypad or bluetooth enabled device.	N/A	942 E0152
	SmartCode™ and HomeConnect™ Electronic Deadbolt	Deadbolt operated by key outside or electronic keypad and thumb turn inside.	N/A	240/250/260/270 620/912/916
	SmartCode™ Lever	Keyed lever operated by key outside or electronic keypad and thumb turn inside.	N/A	917/955

**NOTE:** BHMA code in italics

**ROUND POCKET**

**DOOR LOCK**

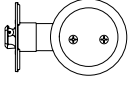
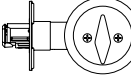
	Function Name	Description	KWIKSET w/ BHMA	KWIKSET SIGNATURE SERIES w/ BHMA
	Passage	Pocket door lock always free.	334	N/A
	Privacy	Pocket door lock operated by thumb turn.	335	N/A

**LIGHT COMMERCIAL**

**LEVER**

**LIGHT COMMERCIAL**

**w/ BHMA**

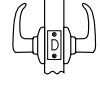
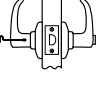
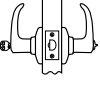
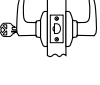
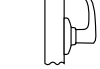
	Function Name	Description		
	Passage/Hall/Closet	Both levers always free.	407/721	F75
	Privacy/Bed/Bath	Both levers locked or unlocked by ADA turn button inside. Outside lever unlocked by emergency key.	408/733F	76
	Entry	Both levers locked or unlocked by key outside or ADA turn button inside.	438/756	F82
	Storeroom/Vestibule	Outside unlocked only while key is turned. Inside always free.	439/781	F86
	Half Dummy Trim, Surface Mounted	For doors where only a pull is required. No operation.	788	

NOTE: BHMA code in italics

**METAL**

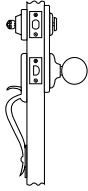
<b>INTERCONNECT</b>	<b>Function Name</b>	<b>Description</b>	<b>METAL INTERCONNECT Model w/BHMA</b>
	Plain Latch	Operated by grip either side. Deadbolt operated by key outside and thumb turn inside. Inside lever simultaneously retracts plain latch and deadbolt latch.	508

NOTE: BHMA code in italics

BOX PACK	Unit					Master Case			
	Quantity	Length (in.)	Width (in.)	Height (in.)	Weight (lbs.)	Quantity	Length (in.)	Width (in.)	Height (in.)
<b>Kwikset Signature Series</b>									
<b>Deadbolts</b>									
780 Single Cylinder	1	4.6730	3.9230	3.0720	2.2500	12	12.8750	12.5000	5.3125
785 Double Cylinder	1	4.6730	3.9230	3.0720	2.7500	12	12.8750	12.5000	5.3125
817 Key Control	1	4.6730	3.9230	3.0720	2.2500	12	12.8750	12.5000	5.3125
817 SQT Key Control Deadbolt	1	4.92	4.13	3.15	2.02	12	12.99	13.19	5.51
980 Single Cylinder	1	4.6730	3.9230	3.0720	2.2500	12	12.8750	12.5000	5.3125
985 Double Cylinder	1	4.6730	3.9230	3.0720	2.7500	12	12.8750	12.5000	5.3125
158 Single Cylinder	1	4.6730	3.9230	3.0720	2.2500	12	12.8750	12.5000	5.3125
159 Single Cylinder	1	4.6730	3.9230	3.0720	2.7500	12	12.8750	12.5000	5.3125
258 Single Cylinder	1	4.81	4.06	3.13	1.76	12	13.37	12.9	6.21
<b>Electronic Deadbolts/Levers</b>									
HomeConnect 620	1	9.50	4.13	4.00	3.12	1	10.23	4.33	4.53
SmartCode 260 TRL	1	4.213	5.353	9.913	3.290	2	10.557	9.180	6.213
Powerbolt 240 TRL	1	3.54	5.38	7.89	1.83	2	8.386	7.795	6.3
Powerbolt 240 CNT	1	3.54	5.38	7.89	1.83	2	8.386	7.795	6.3
Powerbolt 250 TRS	1	3.54	5.38	7.89	1.83	2	8.386	7.795	6.3
SmartCode 260 CNT	1	4.213	5.353	9.913	3.343	2	10.557	9.180	6.213
SmartCode 270 TRL	1	4.213	5.353	9.913	3.307	2	10.557	9.180	6.213
SmartCode 270 CNT	1	4.213	5.353	9.913	3.373	2	10.557	9.180	6.213
912 SmartCode Lever	1	3.5	6	10	61	2	7	12.5	10.4
SmartCode 938/939/942	1	3.5	5.38	9.88	3.14	2	10.50	7.75	5.94
SmartCode 916	1	3.896	4.188	9.667	3.391	1	10.4	4.646	4.52
959 Halo Touch	1	4.19	5.40	9.83	3.76				
<b>Handlesets</b>									
800 AUH Austin	1	15.9380	7.1250	4.0000	7.0000	4	16.4380	15.9380	7.8125
802 AUH Austin	1	15.9380	7.1250	4.0000	6.5000	4	16.4380	15.9380	7.8125
800AVH Avalon	1	15.9380	7.1250	4.0000	7.0000	4	16.4380	15.9380	7.8125
802AVH Avalon	1	15.9380	7.1250	4.0000	6.5000	4	16.4380	15.9380	7.8125
800AN Arlington	1	15.9380	7.1250	4.0000	7.0000	4	16.4380	15.9380	7.8125
802AN Arlington	1	15.9380	7.1250	4.0000	6.5000	4	16.4380	15.9380	7.8125
800CE Chelsea	1	15.9380	7.1250	4.0000	6.0000	4	16.4380	15.9380	16.6255
802CE Chelsea	1	15.9380	7.1250	4.0000	5.5000	4	16.4380	15.9380	16.6255
800HE Hawthorne	1	15.9380	7.1250	4.0000	7.0000	4	16.4380	15.9380	7.8125
802HE Hawthorne	1	15.9380	7.1250	4.0000	5.0000	4	16.4380	15.9380	7.8125
800 Tavaris	1	15.9380	7.1250	4.0000	8.0000	4	16.4380	16.6200	8.3800
802 Tavaris	1	15.9380	7.1250	4.0000	8.0000	4	16.4380	16.6200	8.3800
818 Prescott	1	16.143	7.293	3.75	4.281	4	16.339	15.945	7.677
818 Prague	1	16.142	7.283	3.937	4.079	4	16.142	16.142	7.874
966 Single Cylinder	1	2.7	3.7	4.30	2.25	4	15.20	12.5	7
968 Dummy	1	2.7	3.7	4.30	2.25	4	15.20	12.5	7



BOX PACK	Unit					Master Case			
	Quantity	Length (in.)	Width (in.)	Height (in.)	Weight (lbs.)	Quantity	Length (in.)	Width (in.)	Height (in.)
<b>Kwikset Signature Series Continued</b>									
<b>Knobs</b>									
720 Passage	1	8.1730	3.9230	2.7840	2.0000	12	12.3750	11.5000	8.8125
730 Privacy	1	8.1730	3.9230	2.7840	2.0000	12	12.3750	11.5000	8.8125
740 Entry	1	8.1730	3.9230	2.7840	2.3300	12	12.3750	11.5000	8.8125
788 Dummy	1	3.2360	2.7980	3.0100	0.3500	20	14.8750	12.5000	3.9375
<b>Levers</b>									
720 Passage	1	7.8750	6.1250	3.1875	2.4200	12	19.7500	12.8750	8.5625
730 Privacy	1	7.8750	6.1250	3.1875	2.4200	12	19.7500	12.8750	8.5625
740 Entry	1	7.8750	6.1250	3.1875	2.4200	12	19.7500	12.8750	8.5625
788 Dummy	1	5.8610	3.1100	2.8220	0.4500	20	15.8750	12.1250	6.6245
720 TNL	1	6.625	5.75	3.0	1.65	12	24	15.50	6.70
730 TNL	1	6.625	5.75	3.0	1.70	12	24	15.50	6.85
740 TNL	1	6.625	5.75	3.0	2.05	12	24	15.50	8.30
788 TNL	1	5.861	3.11	2.822	0.450	20	15.875	12.125	6.6245
<b>Kwikset Security Series</b>									
<b>Combo Packs</b>									
690T Tylo Knob and Single Cylinder Deadbolt	1	11.3090	3.4230	2.7840	2.8000	6	8.7500	7.3120	11.9375
<b>Deadbolts</b>									
Double Cylinder Gate Latch	1	4.6730	3.9230	3.0720	2.2500	12	12.8750	12.5000	5.3125
660 Single Cylinder	1	3.9480	3.4230	2.5720	0.5000	12	11.1250	11.0000	4.5625
665 Double Cylinder	1	3.9480	3.4230	2.5720	0.9000	12	11.1250	11.0000	4.5625
663 One-Sided	1	3.9480	3.4230	2.5720	0.5500	12	11.1250	11.0000	4.5625
667 One-Sided	1	3.9480	3.4230	2.5720	0.9000	12	11.1250	11.0000	4.5625
664 Retrofit Kit	1	3.9480	3.4230	2.5720	0.9000	12	11.1250	11.0000	4.5625
<b>Handlesets</b>									
687 LIP	1	15.9380	7.1250	4.0000	3.6000	6	15.0000	12.1250	16.6255
<b>Knobs</b>									
200 Polo	1	8.1730	3.2980	2.7840	1.3000	30	17.1250	17.0000	8.8125
300 Polo	1	8.1730	3.2980	2.7840	1.3000	30	17.1250	17.0000	8.8125
400 Polo	1	8.1730	3.2980	2.7840	1.3000	30	17.1250	17.0000	8.8125
200 Tylo/Cove	1	7.3610	3.2980	2.7840	1.1500	30	17.1250	17.0000	8.1870
300 Tylo/Cove	1	7.3610	3.2980	2.7840	1.1500	30	17.1250	17.0000	8.1870
400 Tylo/Cove	1	7.3610	3.2980	2.7840	1.1500	30	17.1250	17.0000	8.1870
488 Dummy	1	3.2360	2.7980	3.0100	0.3500	20	14.8750	12.5000	3.9375
<b>Lever</b>									
200 Passage	1	6.7980	5.7660	2.9720	1.3500	20	23.6250	15.3750	7.4995
300 Privacy	1	6.7980	5.7660	2.9720	1.3500	20	23.6250	15.3750	7.4995
405 Keyed Lever	1	6.7980	5.7660	2.9720	1.5800	20	23.6250	15.3750	7.4995
488 Dummy	1	5.8610	3.1100	2.8220	0.4500	20	15.8750	12.1250	6.6245
<b>Miscellaneous</b>									
<b>Pocket Door Hardware</b>									
334 Passage	1	4.3750	3.0000	2.0000	.65	12	12.5000	14.3750	2.2500
335 Privacy	1	4.3750	3.0000	2.0000	.8	12	12.5000	14.3750	2.2500

BOX PACK	Unit					Master Case			
	Quantity	Length (in.)	Width (in.)	Height (in.)	Weight (lbs.)	Quantity	Length (in.)	Width (in.)	Height (in.)
<b>Kwikset Multi-Family / Light Commercial</b>									
<b>Carson and Palmina</b>									
407	1	6.75	5.75	2.75	0.5	1	7.93	6.06	3.12
408	1	6.75	5.75	2.75	0.5	1	7.93	6.06	3.12
438	1	6.75	5.75	2.75	1.0	1	7.93	6.06	3.12
439	1	6.75	5.75	2.75	1.0	1	7.93	6.06	3.12
488	1	5.18	3.00	2.43	0.55	1	15.75	12.00	6.56
<b>Kingston</b>									
721KNL	1	6.75	5.75	2.75	1.5	1	7.93	6.06	3.12
733KNL	1	6.75	5.75	2.75	1.5	1	7.93	6.06	3.12
756KNL SMT	1	6.75	5.75	2.75	2.33	1	7.93	6.06	3.12
781KNL SMT	1	6.75	5.75	2.75	2.33	1	7.93	6.06	3.12
788 KNL	1	5.18	3.00	2.43	0.87	1	15.13	12.75	3.50



Customer Service Toll Free Line:  
 (800) 422-LOCK (800) 422-5625  
 FAX (866) 507-8369  
 email: kworders@spectrumbands.com

Date: \_\_\_\_\_ Delivery Address: \_\_\_\_\_ Contact: \_\_\_\_\_  
 PO Number: \_\_\_\_\_ Phone: \_\_\_\_\_ Company Name: \_\_\_\_\_  
 Job Name: \_\_\_\_\_ Fax: \_\_\_\_\_ Address: \_\_\_\_\_  
 Notes: \_\_\_\_\_ Store Number: \_\_\_\_\_

Monday to Friday, 6:00 a.m. to 4:00 p.m. PST

Line No.	Function		Style		Handing	Rose		Finish		OPTIONS					Quantity	Price	Extended Price
	Exterior	Interior	Exterior	Interior		Exterior	Interior	Exterior	Interior	Door Thickness	Latch	Strike	Cylinder	Keying			
1																	
2																	
3																	
4																	
5																	
6																	
7																	
8																	
9																	
10																	
11																	
12																	
13																	
14																	
15																	
16																	
17																	
18																	
19																	
20																	

1666075-01/24

To order service parts, provide service part # and quantity.  
 How to order questions, refer back to page A:3 for General Information.



## PERTH LEVER

Bring a bold look home with Perth™ door levers. The distinct, slender shape was designed for comfort, and the subtle details add a modern touch to any space. Featuring our SmartKey Security™ on the keyed entry lever and a transitional designer rosette on every lever, Perth™ protects against common break-in methods while making a style statement. Elevate your interior and exteriors with Perth™, and enjoy our highest level of security, easiest installation and peace of mind.

- Features New Advanced SmartKey Security\* Technology
- ANSI/BHMA Grade AAA Highest Residential Security/Durability/Finish
- Transitional flat-front lever infused with a bold design with modern touches
- Coordinates well with transitional architecture



Perth Lever with SmartKey Security  
in Satin Nickel

## Specifications

<b>Door Prep</b>	Cross Bore 2-1/8". Edge Bore 1"
<b>Backset</b>	Adjustable 2 3/8" or 2 3/4"
<b>Door Thickness</b>	1 3/8" - 1 3/4" Doors standard Thick Door Kit Available for 720 & 740 functions
<b>Cylinder</b>	SmartKey Security™
<b>Faceplates</b>	1" x 2 1/4" includes round corner, square corner and drive-in
<b>Strikes</b>	Includes 2 1/4" full lip round corner, other options available
<b>Bolt</b>	1/2" Throw
<b>Door Handing</b>	Reversible for right or left hand doors.
<b>ANSI/BHMA</b>	A156.30 Grade AAA certified
<b>ADA</b>	720 & 730 functions are in compliance with the American National Standards Institute (ANSI A117.1)
<b>UL</b>	N/A
<b>Warranty</b>	Lifetime Mechanical and Lifetime Finish

## Dimensions

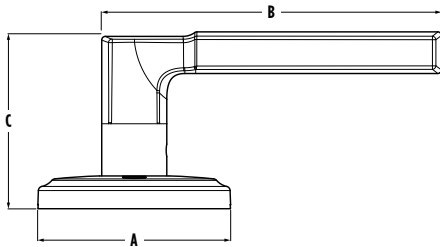

Design	A	B	C	C (Keyed)
Perth	2 21/32"	4 1/4"	2 7/16"	2 11/32"

## Finishes



Matte  
Black 514



Satin  
Nickel 15

## Functions



**Passage/Hall/Closet:** Both levers  
always free. - 720PHL



**Privacy/Bed/Bath:** Both levers locked  
or unlocked by push-button inside.  
Outside lever unlocked by emergency  
key. - 730PHL



**Keyed Entry Lever:** Both sides locked  
or unlocked by key outside or turn-  
button inside. - 740PHL



**Half Dummy Trim, Surface Mounted:**  
For doors where only a pull is required.  
No operation. - 788PHL



**Interior Pack:** Inside lever of handleset.  
800/802 : Handlesets  
- 966PHL : Single-Cylinder  
- 968PHL : Dummy  
818/819 : Handlesets  
- 971PHL : Single-Cylinder  
- 973PHL : Dummy



## One Key For All Your Locks

Protects against  
advanced break-in  
techniques and allows  
you to re-key your lock  
yourself in seconds.



**LIFETIME**  
WARRANTY



## SEDONA LEVER

Sedona™ is a modern take on a classic design. The updated wave shape is carefully sculpted and features a slim, elegant profile. Its round designer rosette will create a balanced look on your doors, while the collection offers a solution for both aesthetics and security. The exterior door lock comes with our patented SmartKey Security™, making it bump-resistant, pick-resistant and re-keyable within seconds. Style your interior and exteriors with Sedona™, and enjoy an elevated look, easy installation and peace of mind.

- Features New Advanced SmartKey Security\* Technology
- ANSI/BHMA Grade AAA Highest Residential Security/Durability/Finish
- Transitional wave lever for a classic look with modern touches
- Coordinates well with transitional architecture



Sedona Lever with SmartKey Security  
in Satin Nickel

## Specifications

<b>Door Prep</b>	Cross Bore 2-1/8". Edge Bore 1"
<b>Backset</b>	Adjustable 2 3/8" or 2 3/4"
<b>Door Thickness</b>	1 3/8" - 1 3/4" Doors standard Thick Door Kit Available for 720 & 740 functions
<b>Cylinder</b>	SmartKey Security™
<b>Faceplates</b>	1" x 2 1/4" includes round corner, square corner and drive-in
<b>Strikes</b>	Includes 2 1/4" full lip round corner, other options available
<b>Bolt</b>	1/2" Throw
<b>Door Handing</b>	Sedona half dummy & interior pack functions are available as either right hand or left hand
<b>ANSI/BHMA</b>	A156.30 Grade AAA certified
<b>ADA</b>	720 & 730 functions are in compliance with the American National Standards Institute (ANSI A117.1)
<b>UL</b>	N/A
<b>Warranty</b>	Lifetime Mechanical and Lifetime Finish

## Dimensions

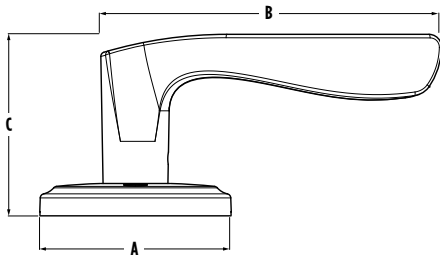

Design	A	B	C	B (Keyed)	C (Keyed)
Sedona	2 21/32"	4 1/4"	2 17/32"	4 9/32"	2 5/16"

## Finishes



Matte  
Black 514



Satin  
Nickel 15



Satin  
Brass 4

**LIFETIME**  
WARRANTY

## Functions



**Passage/Hall/Closet:** Both levers  
always free. - 720SEL



**Privacy/Bed/Bath:** Both levers locked  
or unlocked by push-button inside.  
Outside lever unlocked by emergency  
key. - 730SEL



**Keyed Entry Lever:** Both sides locked  
or unlocked by key outside or turn-  
button inside. - 740SEL



**Half Dummy Trim, Surface Mounted:**  
For doors where only a pull is required.  
No operation. - 788SEL



**Interior Pack:** Inside lever of handleset.  
800/802 : Handlesets  
- 966SEL : Single-Cylinder  
- 968SEL : Dummy  
818/819 : Handlesets  
- 971SEL : Single-Cylinder  
- 973SEL : Dummy



## One Key For All Your Locks

Protects against  
advanced break-in  
techniques and allows  
you to re-key your lock  
yourself in seconds.





## TRAFFORD LEVER

Elevate your space with the timeless Trafford™ collection. The classic shape and clean appearance complement any home aesthetic, and the unique designer rosette will add a warm and welcoming touch to your doors. Create your desired look with three premium finishes, then let our bump-resistant and pick-resistant SmartKey Security™ protect what matters most. Adorn your interior and exteriors with Trafford™ levers, and enjoy our highest level of security, easiest installation and peace of mind.

- Features New Advanced SmartKey Security\* Technology
- ANSI/BHMA Grade AAA Highest Residential Security/Durability/Finish
- Traditional bent lever for a timeless, warm & elegant look



Trafford Lever with SmartKey Security  
in Venetian Bronze



## Specifications

<b>Door Prep</b>	Cross Bore 2-1/8". Edge Bore 1"
<b>Backset</b>	Adjustable 2 3/8" or 2 3/4"
<b>Door Thickness</b>	1 3/8" - 1 3/4" Doors standard Thick Door Kit Available for 720 & 740 functions
<b>Cylinder</b>	SmartKey Security™
<b>Faceplates</b>	1" x 2 1/4" includes round corner, square corner and drive-in
<b>Strikes</b>	Includes 2 1/4" full lip round corner, other options available
<b>Bolt</b>	1/2" Throw
<b>Door Handing</b>	Reversible for right or left hand doors
<b>ANSI/BHMA</b>	A156.30 Grade AAA certified
<b>ADA</b>	720 & 730 functions are in compliance with the American National Standards Institute (ANSI A117.1)
<b>UL</b>	N/A
<b>Warranty</b>	Lifetime Mechanical and Lifetime Finish

## Dimensions

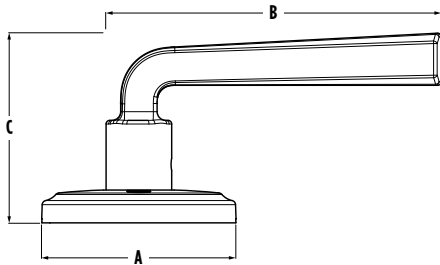

Design	A	B	C	C (Keyed)
Trafford	2 21/32"	4 5/32"	2 19/32"	2 9/16"

## Finishes



Matte  
Black **514**



Satin  
Nickel **15**



Venetian  
Bronze **11P**

## Functions



**Passage/Hall/Closet:** Both levers  
always free. - 720TDL



**Privacy/Bed/Bath:** Both levers locked  
or unlocked by push-button inside.  
Outside lever unlocked by emergency  
key. - 730TDL



**Keyed Entry Lever:** Both sides locked  
or unlocked by key outside or turn-  
button inside. - 740TDL



**Half Dummy Trim, Surface Mounted:**  
For doors where only a pull is required.  
No operation. - 788TDL



**Interior Pack:** Inside lever of handleset.  
800/802 : Handlesets  
- 966TDL : Single-Cylinder  
- 968TDL : Dummy  
818/819 : Handlesets  
- 971TDL : Single-Cylinder  
- 973TDL : Dummy



## One Key For All Your Locks

Protects against  
advanced break-in  
techniques and allows  
you to re-key your lock  
yourself in seconds.



**LIFETIME**  
WARRANTY



**Kwikset**

# HALI CONTEMPORARY INTERCONNECT

The perfect solution for multi-family housing, Interconnect provides quality, security and style while meeting ADA requirements and fire code ratings.

- Features SmartKey Security™ Re-key Technology with BumpGuard™ Protection
- Lifetime mechanical and finish warranty
- Lever options are in compliance with the American National Standards Institute (ANSI A117.1) and the Americans with Disabilities Act (ADA)
- Meets fire code rating for emergency panic exit

**#1 SELLING U.S. LOCK BRAND\***

\*Source: TraQline US quarterly brand unit share report, Q4 2006 through Q1 2021

# Interconnect Specifications

<b>Door Prep</b>	2 1/8" diameter face hole & 1" diameter latch hole
<b>Backset</b>	DB: Adjustable to 2 3/8" or 2 3/4" Lever: Fixed 2 3/8" or Fixed 2 3/4"
<b>Door Thickness</b>	Door Kits Available
<b>Cylinder</b>	SmartKey™ on 780 Deadbolt and Smartkey™ on KCDB SQT
<b>Faceplates</b>	Square or round corner
<b>Strikes</b>	Round corner strike, round corner with full lip, square metal jam and square corner strike
<b>Door Handing</b>	Reversible
<b>ANSI/BHMA</b>	Grade 3
<b>ADA</b>	Lever options are in compliance with the American National Standards Institute (ANSI A117.1) and the Americans with Disabilities Act (ADA)
<b>UL</b>	Meets 3 hour fire rating.

# Dimensions

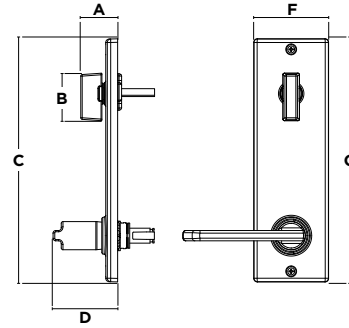

Design	A	B	C	D	E	F
Interior	1 13/32"	1 3/4"	9 3/16"	2 7/16"	5 1/2"	2 27/32"

# Finishes



Satin Nickel 15



Matte Black 514



Polished Chrome 26

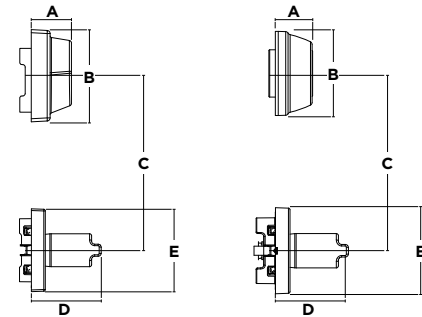

Design	A	B	C	D	E
508HRL KCDB	1 5/16"	2 31/32"	5 1/2"	2 1/4"	2 67/100"
508HRL	1 5/32"	2 5/8"	5 1/2"	2 1/4"	2 67/100"



## Re-Key Your Lock Yourself in Seconds

! Make sure you have your current key and SmartKey tool

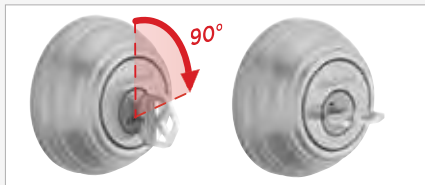

**1** Insert the key that currently operates your lock, and rotate it 90° clockwise.

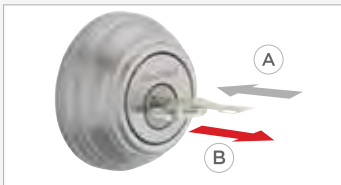

**2** **A** Insert the SmartKey tool fully and firmly into the SmartKey hole.  
**B** Remove the SmartKey tool and the current key.

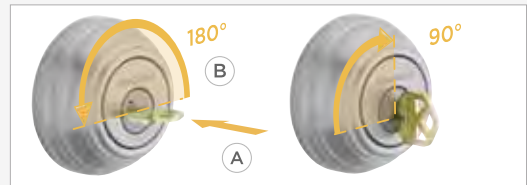

**3** **A** Fully insert your new key into the lock, and rotate it 180°.  
**B** Rotate the new key 90° back to the starting position, and remove it. Your lock is now re-keyed to your new key, and your old key will no longer operate the lock.





### Superior Security Features

- ANSI/BHMA Grade 1 Certified 980/985 Deadbolt
- SmartKey Security - providing superior security against advanced break-in techniques.

### Elegant Styles And Finishes

- Traditional to Contemporary Styles

### Warranty

- Lifetime Mechanical
- Lifetime Finish





| **Abbey\***



| **Arroyo**



| **Hancock\***



| **Laurel\***



| **Pismo**



| **Halifax\***



| **Halifax\***  
**San Clemente Trim**



| **Katella**



| **Lisbon**



| **Milan\***



| **Perth**



| **Sedona**



| **Singapore**



| **Trafford**



| **Tripoli**



| **Tustin\***

**Vancouver**



**Prague**



**Prescott**



**San Clemente**



Vancouver	Model	Function	Finish							Case		
			3	L03	5	11P	15	26	26D	514	Qty	
818VNH SMT	Single Cylinder					\$340.20	\$340.20	\$340.20			\$351.50	4
819VNH	Dummy					\$306.20	\$306.20	\$306.20			\$317.50	4

Prague	Model	Function	Finish							Case		
			3	L03	5	11P	15	26	26D	514	Qty	
818PGH SMT	Single Cylinder					\$327.80	\$327.80	\$327.80			\$339.10	4
819PGH	Dummy					\$293.80	\$293.80	\$293.80			\$305.10	4
814PGH	Handle Only					\$250.70	\$250.70	\$250.70			\$262.00	4

Prescott	Model	Function	Finish							Case		
			3	L03	5	11P	15	26	26D	514	Qty	
818PTH SMT	Single Cylinder			\$296.00		\$296.00	\$296.00				\$307.30	4
819PTH	Dummy			\$262.00		\$262.00	\$262.00				\$273.30	4
814PTH	Handle Only			\$218.90		\$218.90	\$218.90				\$230.20	4
815PTH	Handleset with Tustin			\$298.30		\$298.30	\$298.30					4
815PTH	Handleset with Hancock			\$285.70		\$285.70	\$285.70					4

San Clemente	Model	Function	Finish							Case			
			3	4	5	11P	15	26	26D	514	Qty		
818SCE SMT	Single Cylinder			\$339.10			\$327.80	\$327.80	\$327.80	\$327.80	\$327.80	\$339.10	4
819SCE	Dummy			\$305.10			\$293.80	\$293.80	\$293.80	\$293.80	\$293.80	\$305.10	4
814SCE	Handle Only <sup>†</sup>						\$250.70	\$250.70	\$250.70			\$262.00	4
815SCE	Handle with Halifax Lever <sup>†</sup>						\$330.10	\$330.10	\$330.10			\$341.40	4

**NOTE:** Handlesets ordered LIP only  
**Denotes handleset without deadbolt**

1666075-01/24

**Austin™**



**Avalon™**



**Austin™**

Model	Function	Finish								Case
		3	L03	5	11P	15	26	26D	514	Qty
800AUH SMT	Single Cylinder				\$330.00	\$330.00				4
802AUH	Dummy				\$280.20	\$280.20				4
814AUH	Handle Only†				\$237.10	\$237.10				4

**Avalon™**

Model	Function	Finish								Case
		3	L03	5	11P	15	26	26D	514	Qty
800AVH SMT	Single Cylinder				\$330.00	\$330.00			\$341.00	4
802AVH	Dummy				\$280.20	\$280.20			\$291.50	4
814AVH	Handle Only†				\$237.10	\$237.10			\$248.10	4

**NOTE:** Handlesets ordered LIP only  
 †Denotes handleset without deadbolt



**Hawthorne**



**Tavaris\***



Hawthorne	Model	Function	Finish							Case		
			3	L03	5	11P	15	26	26D	514	Qty	
	800HE SMT	Single Cylinder				\$311.00	\$311.00				\$322.00	4
	802HE	Dummy				\$262.00	\$262.00				\$273.30	4
	814HE	Handle Only†				\$218.90	\$218.90				\$229.90	4

Tavaris*	Model	Function	Finish							Case		
			3	L03	5	11P	15	26	26D	514	Qty	
	800TVH SMT	Single Cylinder				\$311.00	\$311.00	\$311.00	\$311.00	\$322.00	\$322.00	4
	802TVH	Dummy				\$262.00	\$262.00	\$262.00	\$262.00	\$273.30	\$273.30	4
	814TVH	Handle Only†				\$218.90	\$218.90	\$218.90		\$230.20	\$230.20	4

**NOTE:** Handlesets ordered LIP only  
 †Denotes handleset without deadbolt

**Arlington\***



**Chelsea\***



Arlington*	Model	Function	Finish							Case		
			3	L03	5	11P	15	26	26D	514	Qty	
	800AN SMT	Single Cylinder		\$257.00		\$257.00	\$257.00					4
	802AN	Dummy		\$211.00		\$211.00	\$211.00					4
	814AN	Handle Only†		\$167.90		\$167.90	\$167.90					4
	815AN	Handleset† with Tustin				\$247.30	\$247.30					6
	815AN	Handleset† with Hancock		\$234.70		\$234.70	\$234.70					6

Chelsea*	Model	Function	Finish							Case		
			3	L03	5	11P	15	26	26D	514	Qty	
	800CE SMT	Single Cylinder		\$257.00		\$257.00	\$257.00	\$257.00				4
	802CE	Dummy		\$211.00		\$211.00	\$211.00	\$211.00				4
	814CE	Handle Only†					\$167.90					4
	815CE	Handleset† with Hancock					\$234.70					6

**NOTE:** Handlesets ordered LIP only  
 †Denotes handleset without deadbolt

**INTERIOR PACKS FOR TRADITIONAL 800/802 HANDLESETS**

Model	Function	Series			
		Signature Lever & Laurel	Signature Knob	Security Lever	Security Knob
966	Single Cylinder	\$81.00	\$67.20	\$72.90	\$59.00
968	Dummy	\$67.20	\$53.40	\$61.60	\$47.70

Handleset Interior Pack Finish Options		3	L03	4	5	11P	15	26	26D	514	Qty
	Halifax Lever					•	•	•	•	•	4
	Hancock Knob	•				•	•	•	•	•	4
	Katella Lever						•			•	4
	Laurel Knob					•	•	•		•	4
	Lisbon Lever					•	•	•		•	4
	Milan Lever					•	•	•	•	•	4
	Perth Lever						•			•	4
	Pismo Knob					•	•	•	•	•	4
	Sedona Lever			•			•			•	4
	Singapore Lever					•	•	•		•	4
Trafford Lever					•	•			•	4	
	Tustin Lever	•				•	•	•	•	•	4
	Aliso Knob						○				4
	Balboa Lever					○	○	○	○	○	4
	Breton Lever						○	○		○	4
	Casey Lever						○	○		○	4
	Cove Knob					○	○			○	4
	Delta Lever					○	○	○	○		4
	Dorian Lever					○	○				4
	Henley Lever						○			○	4
	Ladera Lever						○	○	○	○	4
	Polo Knob				○	○	○	○	○		4
	Tylo Knob	○			○		○	○	○		4

**SECTIONAL INTERIOR PACKS FOR LOW PROFILE 818/819 HANDLESETS**

Model	Function	Series			
		Signature Lever	Signature Knob	Security Lever	Security Knob
971	Single Cylinder	\$81.00	\$67.20	\$72.90	
973	Dummy	\$67.20	\$53.40	\$61.60	

Handleset Interior Pack Finish Options		3	L03	4	5	11P	15	26	26D	514	Qty
	Arroyo Knob						•	•		•	4
	Halifax Lever			•••		•	•	•	•	•	4
	Halifax RCT Lever						•	•		•	4
	Hancock Knob					•	•			•	4
	Katella Lever						•			•	4
	Lisbon Lever					•	•	•		•	4
	Milan Lever					•	•	•	•	•	4
	Perth Lever						•			•	4
	Pismo Knob			•		•	•	•	•	•	4
	Sedona Lever			•			•			•	4
Singapore Lever*			•		•	•	•		•	4	
Trafford Lever					•	•			•	4	
Tripoli Lever						•	•		•	4	
	Tustin Lever	•				•	•			•	4
	Breton Lever*						○	○		○	4
	Casey Lever*						○	○		○	4

\*Available in SQT only  
\*\*Not available in RCT trim

**Note:** Square (SQT) or Round (RDT) rose options available

○ Only available in Single Cyl Function Only



**FULL SQUARE INTERIOR PACKS FOR LOW PROFILE 818/819 HANDLESETS**



Model	Function	Series			
		Signature Lever	Signature Knob	Security Lever	Security Knob
971 SQF	Single Cylinder	\$92.30			
973 SQF	Dummy	\$78.50			

Handleset Interior Pack Finish Options	3	L03	5	11P	15	26	26D	514	Qty
 Halifax Lever				•	•	•		•	4

**Note: Only square (SQF) rose option available**

**Halifax™**

	Model	Function	Finish							Case Qty
			4	11P	15	26	26D	514	514x26	
				720HFL	Hall/Closet	\$75.00	\$71.40	\$71.40	\$71.40	
	720HFL	Hall/Closet UL (20 Min FD)			\$73.90	\$73.90	\$73.90	\$77.50		12
	725HFL*	Hall/Closet UL (3 Hr.)			\$77.40	\$77.40	\$77.40	\$81.00		12
	730HFL	Bed/Bath	\$78.30	\$74.70	\$74.70	\$74.70	\$74.70	\$78.30	\$78.30	12
	740HFL SMT	Entry	\$127.90	\$124.30	\$124.30	\$124.30	\$124.30	\$127.90	\$127.90	12
	745HFL SMT*	Entry UL (3 Hr.)			\$130.30	\$130.30	\$130.30	\$133.90		12
	788HFL	Half Dummy	\$37.50	\$35.70	\$35.70	\$35.70	\$35.70	\$37.50		20

**NOTE:** Can be ordered with (RDT) Round Rose or (SQT) Square Rose option. Example - 720HFL RDT 11P, \*(SQT) Square Rose Only

**Halifax™  
San Clemente  
Trim**

	Model	Function	Finish							Case Qty	
			3	L03	5	11P	15	26	26D		514
				720HFL RCT	Hall/Closet						\$80.20
	730HFL RCT	Bed/Bath					\$83.70	\$83.70		\$87.30	12
	740HFL RCT SMT	Entry					\$135.20	\$135.20		\$138.80	12
	788HFL RCT	Half Dummy					\$40.00	\$40.00		\$41.90	20

**Lisbon**

	Model	Function	Finish							Case Qty	
			3	L03	5	11P	15	26	26D		514
				720LSL	Hall/Closet				\$71.40		\$71.40
	730LSL	Bed/Bath				\$74.70	\$74.70	\$74.70		\$78.30	12
	740LSL SMT	Entry				\$124.30	\$124.30	\$124.30		\$127.90	12
	788LSL	Half Dummy				\$35.70	\$35.70	\$35.70		\$37.50	20

**NOTE:** Can be ordered with (RDT) Round Rose or (SQT) Square Rose option. Example - 720LSL RDT 11P

**Milan™**

	Model	Function	Finish							Case Qty	
			3	L03	5	11P	15	26	26D		514
				720MIL	Hall/Closet				\$71.40		\$71.40
	720MIL	Hall/Closet UL (20 Min FD)					\$73.90	\$73.90	\$73.90	\$77.50	12
	730MIL	Bed/Bath				\$74.70	\$74.70	\$74.70	\$74.70	\$78.30	12
	740MIL SMT	Entry				\$124.30	\$124.30	\$124.30	\$124.30	\$127.90	12
	788MIL	Half Dummy				\$35.70	\$35.70	\$35.70	\$35.70	\$37.50	20

**NOTE:** Can be ordered with (RDT) Round Rose or (SQT) Square Rose option. Example - 720MIL SQT 11P

**Perth**

	Model	Function	Finish							Case Qty	
			3	4	5	11P	15	26	26D		514
				720PHL	Hall/Closet						\$71.40
	730PHL	Bed/Bath					\$74.70			\$78.30	12
	740PHL SMT	Entry					\$124.30			\$127.90	12
	788PHL	Half Dummy					\$35.70			\$37.50	20

**Sedona**

	Model	Function	Finish							Case Qty	
			3	4	5	11P	15	26	26D		514
				720SEL	Hall/Closet		\$75.00				\$71.40
	730SEL	Bed/Bath		\$78.30			\$74.70			\$78.30	12
	740SEL SMT	Entry		\$127.90			\$124.30			\$127.90	12
	788SEL	Half Dummy		\$37.50			\$35.70			\$37.50	20

**Katella**

	Model	Function	Finish								Case Qty	
			3	L03	5	11P	15	26	26D	514		
	720KAL	Hall/Closet					\$71.40				\$75.00	12
	730KAL	Bed/Bath					\$74.70				\$78.30	12
	740KAL SMT	Entry					\$124.30				\$127.90	12
	788KAL	Half Dummy					\$35.70				\$37.50	20

**Singapore**

	Model	Function	Finish								Case Qty	
			3	L03	4*	5	11P	15	26	26D		514
	720SAL	Hall/Closet			\$75.00		\$71.40	\$71.40	\$71.40		\$75.00	12
	730SAL	Bed/Bath			\$78.30		\$74.70	\$74.70	\$74.70		\$78.30	12
	740SAL SMT	Entry			\$127.90		\$124.30	\$124.30	\$124.30		\$127.90	12
	788SAL	Half Dummy			\$37.50		\$35.70	\$35.70	\$35.70		\$37.50	20

\*Available in SQT only

**Trafford**

	Model	Function	Finish								Case Qty	
			3	L03	5	11P	15	26	26D	514		
	720TDL	Hall/Closet					\$71.40	\$71.40			\$75.00	12
	730TDL	Bed/Bath					\$74.70	\$74.70			\$78.30	12
	740TDL SMT	Entry					\$124.30	\$124.30			\$127.90	12
	788TDL	Half Dummy					\$35.70	\$35.70			\$37.50	20

**Tripoli**

	Model	Function	Finish								Case Qty	
			3	L03	5	11P	15	26	26D	514		
	720TPL MDT	Hall/Closet						\$71.40	\$71.40		\$75.00	12
	730TPL MDT	Bed/Bath						\$74.70	\$74.70		\$78.30	12
	740TPL MDT SMT	Entry						\$124.30	\$124.30		\$127.90	12
	788TPL MDT	Half Dummy						\$35.70	\$35.70		\$37.50	20

**NOTE:** MDT=Midtown

**Tustin™**

	Model	Function	Finish								Case Qty	
			3	L03	5	11P	15	26	26D	514		
	720TNL	Hall/Closet	\$55.00				\$60.60	\$60.60	\$60.60	\$60.60	\$64.20	12
	730TNL	Bed/Bath	\$58.30				\$63.90	\$63.90	\$63.90	\$63.90	\$67.50	12
	740TNL	Entry					\$89.50	\$89.50	\$89.50	\$89.50		12
	740TNL SMT	Entry	\$83.90				\$89.50	\$89.50	\$89.50	\$89.50	\$93.10	12
	788TNL	Half Dummy	\$27.50				\$30.30	\$30.30	\$30.30	\$30.30	\$32.10	20

	Model	Function	Finish								Case
			3	L03	5	11P	15	26	26D	514	Qty
	720L	Hall/Closet				\$58.90	\$58.90	\$58.90		\$62.40	12
	730L	Bed/Bath				\$62.50	\$62.50	\$62.50		\$66.00	12
	740L SMT	Entry				\$87.30	\$87.30	\$87.30		\$90.80	12
	788L	Half Dummy				\$29.45	\$29.45	\$29.45		\$31.20	20

	Model	Function	Finish								Case	
			3	L03	4	5	11P	15	26	26D	514	Qty
	720PSK	Hall/Closet			\$53.70		\$50.20	\$50.20	\$50.20	\$50.20	\$53.70	12
	730PSK	Bed/Bath			\$57.30		\$53.80	\$53.80	\$53.80	\$53.80	\$57.30	12
	740PSK SMT	Entry			\$82.10		\$78.60	\$78.60	\$78.60	\$78.60	\$82.10	12
	788PSK	Half Dummy			\$26.85		\$25.10	\$25.10	\$25.10	\$25.10	\$26.85	20

**NOTE:** Can be ordered with (RDT) Round Rose or (SQT) Square Rose option. Example - 720PSK RDT 514

	Model	Function	Finish								Case
			3	L03	5	11P	15	26	26D	514	Qty
	720H	Hall/Closet	\$35.80			\$41.70	\$41.70	\$41.70	\$41.70	\$45.20	12
	730H	Bed/Bath	\$39.40			\$45.30	\$45.30	\$45.30	\$45.30	\$48.80	12
	740H	Entry	\$59.20			\$65.10	\$65.10	\$65.10	\$65.10	\$68.60	12
	740H SMT	Entry	\$64.20			\$70.10	\$70.10	\$70.10	\$70.10	\$73.60	12
	745H SMT	Entry UL	\$70.20			\$76.10	\$76.10	\$76.10	\$76.10	\$79.60	12
	750H	Storeroom	\$64.20				\$70.10		\$70.10		12
	750H SMT	Storeroom	\$69.20				\$75.10		\$75.10		12
	788H	Half Dummy	\$17.90			\$20.85	\$20.85	\$20.85	\$20.85	\$22.60	20

	Model	Function	Finish								Case
			3	L03	5	11P	15	26	26D	514	Qty
	720A	Hall/Closet	\$33.90							\$39.80	12
	730A	Bed/Bath	\$37.50							\$43.40	12
	740A SMT	Entry	\$62.30							\$68.20	12
	745A SMT	Entry UL	\$68.30							\$74.20	12
	750A SMT	Storeroom	\$67.30							\$73.20	12
	788A	Half Dummy	\$16.95							\$19.90	20

	Model	Function	Finish								Case
			3	L03	5	11P	15	26	26D	514	Qty
	720AYK MDT	Hall/Closet					\$50.20	\$50.20		\$53.70	12
	730AYK MDT	Bed/Bath					\$53.80	\$53.80		\$57.30	12
	740AYK MDT SMT	Entry					\$78.60	\$78.60		\$82.10	12
	788AYK MDT	Half Dummy					\$25.10	\$25.10		\$26.85	20

**980/985**



Model	Function	Finish								Case Qty
		3	L03	5	11P	15	26	26D	514	
980 SMT	Single Cylinder				\$92.20	\$92.20			\$96.00	12
982 SMT	Single Cylinder UL (3 Hr.)					\$93.90			\$97.50	12
985 SMT	Double Cylinder				\$125.00	\$125.00			\$128.80	12

**Uptown Deadbolt**



Model	Function	Function								Case Qty
		4	5	11P	15	26	26D	514		
258 RDT SMT	Single Cylinder	\$91.50		\$87.90	\$87.90	\$87.90	\$87.90	\$91.50	12	
258 RDT SMT	Single Cylinder UL (20 Min FD)							\$94.00	12	

**Downtown Deadbolt**



Model	Function	Function								Case Qty
		4	5	11P	15	26	26D	514		
258 SQT SMT	Single Cylinder	\$91.50		\$87.90	\$87.90	\$87.90	\$87.90	\$91.50	12	
258 SQT SMT	Single Cylinder UL (20 Min FD)							\$94.00	12	

**Midtown Deadbolt**



Model	Function	Function								Case Qty
		5	11P	15	26	26D	514			
258 MDT	Single Cylinder			\$87.90	\$87.90		\$91.50	12		

**San Clemente Rectangular Deadbolt**



Model	Function	Function								Case Qty
		5	11P	15	26	26D	514			
258 RCT SMT	Single Cylinder			\$96.60	\$96.60		\$100.10	12		



**780/785**

	Model	Function	Finish									Case
			3	L03	5	11P	15	26	26D	514	11Px26	
	780	Single Cylinder	\$68.30			\$78.20	\$78.20	\$78.20	\$78.20	\$81.90		12
	780 SMT	Single Cylinder	\$68.30			\$78.20	\$78.20	\$78.20	\$78.20	\$81.90	\$78.20	12
	782 SMT	Single Cylinder UL (3 Hr.)					\$80.50		\$80.50	\$84.10		12
	785	Double Cylinder	\$101.10			\$111.00	\$111.00	\$111.00	\$111.00	\$114.80		12
	785 SMT	Double Cylinder	\$101.10			\$111.00	\$111.00	\$111.00	\$111.00	\$114.80		12

**Halifax Deadbolt**

	Model	Function	Function								Case	
			11P	15	26	26D	514	11Px15	11Px26	15x26		514x26
	158 SQT SMT	Single Cylinder	\$78.20	\$78.20	\$78.20	\$78.20	\$81.90				\$81.90	12
	158 SQT SMT	Single Cylinder UL (20 Min FD)		\$80.70			\$84.40					12
	982 SQT SMT	Single Cylinder UL (3 Hr.)		\$80.50	\$80.50	\$80.50	\$84.10					12
	159 SQT SMT	Double Cylinder	\$111.00	\$111.00	\$111.00	\$111.00	\$114.80					12

**Milan Deadbolt**

	Model	Function	Finish									Case
			3	L03	5	11P	15	26	26D	514	514x26	
	158 RDT SMT	Single Cylinder				\$78.20	\$78.20	\$78.20	\$78.20	\$81.90	\$81.90	12
	158 RDT SMT	Single Cylinder UL (20 Min FD)					\$80.70			\$84.40		12
	982 RDT SMT	Single Cylinder UL (3 Hr.)					\$80.50	\$80.50	\$80.50	\$84.10		12
	159 RDT SMT	Double Cylinder				\$111.00	\$111.00	\$111.00	\$111.00	\$114.80		12





**KWIKSET SIGNATURE SERIES HANDLESETS**

Door Prep	<b>Deadbolt:</b> Cross Bore 2-1/8" or 1-1/2". Edge Bore 1". <b>Handle:</b> Cross Bore 2-1/8". Edge Bore 1".
Backset	<b>Deadbolt:</b> Adjustable to 2-3/8" or 2-3/4". <b>Handle:</b> Adjustable to 2-3/8" or 2-3/4".
Door Thickness	1-3/4" doors standard. 2-1/4" doors optional. Not designed for use on 1-3/8" doors.
Cylinder	SmartKey Security
Faceplate	1" x 2-1/4". Specify round corner, square corner or drive-in.
Strikes	<b>Deadbolt:</b> 2.74" x 1.115" round corner and square corner. 2.25" x 1.75" 5303 round corner full lip strike (grade 3 when used) Other strikes are available as service parts. <b>Handle:</b> 2-1/4" round corner and square corner full lip. Other options available as service parts.
Bolt	<b>Deadbolt:</b> 1" throw. <b>Handle:</b> 1/2" throw.
Door Handing	Reversible for right or left-hand doors.
ANSI/BHMA	Deadbolt is Grade 1 Certified.
ADA	N/A
UL	N/A

**KWIKSET SIGNATURE SERIES LEVERS**

Door Prep	Cross Bore 2-1/8" Edge Bore 1" Latch Face 1" x 2-1/4"
Backset	Adjustable 2-3/8" or 2-3/4".
Door Thickness	1-3/8" - 1-3/4" doors standard. 2-1/4" doors optional on 720 and 740 models. Up to 2-1/8" doors optional on HFL/MIL/LSL/MRL/SAL
Cylinder	SmartKey Security
Rose	Specify round or square rose - HFL, LSL, MIL, SAL
Faceplate	1" x 2-1/4" round corner, square corner and drive in collar. Round front comes staked.
Strikes	2-1/4" round corner full lip. Other options available as service parts.
Bolt	1/2" throw
Door Handing	Specify handing only with Tustin and Sedona inactive levers
ANSI/BHMA	Grade 2 Certified.
ADA	All families except Tustin in Functions Passage, Privacy are in compliance with the American National Standards Institute (ANSI A117.1) and the Americans with Disabilities Act (ADA).
UL	UL 3 hour fire rating and 1/3 hour fire rating available on select families.

**KWIKSET SIGNATURE SERIES KNOBS**

Door Prep	Cross Bore: 2-1/8" Edge Bore: 1" Latch Face: 1"x 2-1/4".
Backset	Adjustable to 2-3/8" or 2-3/4".
Door Thickness	1-3/8" - 1-3/4" doors standard.
Cylinder	SmartKey Security or Pin & Tumbler.
Faceplate	1" x 2-1/4" round corner, square corner and drive-in collar.
Strikes	2-1/4" round corner full lip. Other options available as service parts.
Bolt	1/2" throw.
Door Handing	Reversible for right- or left-hand doors.
ANSI/BHMA	Grade 2 Certified
ADA	N/A
UL	N/A

**VANCOUVER HANDLESET**

Door Prep (Deadbolt/Handle)	Crossbore 2-1/8". Edge Bore 1". Latch Face 1" x 2-1/4" Deadbolt & Handle bore holes must be 5-1/2" apart
Backset (Deadbolt/Handle)	Adjustable 2-3/8" or 2-3/4"
Door Thickness	1-3/4" Standard. Thick door service part available for up to 2-1/4"
Cylinder	SmartKey Security
Faceplate	1" x 2-1/4". Square, round, or drive in <b>Deadbolt:</b> 2.74" x 1.115" round corner and square corner 2.25" x 1.75" 5303 round corner full lip strike (grade 3 when used) <b>Handle:</b> 2-1/4" round corner and square corner full lip. Other options available as service parts.
Strikes	Other strikes are available as service parts.
Bolt	<b>Deadbolt:</b> 1" Throw <b>Handle:</b> 1/2" Throw
Door Handing	Reversible for right or left-hand doors.
ANSI/BHMA	Deadbolt - A156.39 Grade AAA Certified
ADA	N/A
UL	N/A

\*Optional UL 1/3 hour list price charge is \$2.50.



**KWIKSET SIGNATURE SERIES  
158/159 CONTEMPORARY DEADBOLTS**

Door Prep	Cross Bore 2-1/8" or 1-1/2". Edge Bore 1".
Backset	Adjustable 2-3/8" or 2-3/4".
Door Thickness	1-3/8" - 1-3/4".
Cylinder	SmartKey Security
Rose	Specify round or square rose
Strikes	2.74" x 1.115" round corner and square corner 2.25" x 1.75" 5303 round corner full lip strike (grade 3 when used) Other strikes are available as service parts.
Bolt	1" Throw Steel.
ANSI/BHMA	A156.36 Grade 2
ADA	Interior turn pieces are in compliance with the American National Standards Institute (ANSI A117.1) and the Americans with Disabilities Act (ADA).
UL	UL 3 hour and 1/3 hour fire rating available on select SKUs.

**KWIKSET SIGNATURE SERIES  
780-785 DEADBOLTS**

Door Prep	780, 785: Crossbore 2-1/8" or 1-1/2". Edge Bore 1".
Backset	Adjustable 2-3/8" or 2-3/4" standard.
Door Thickness	1-3/8" - 1-3/4" doors standard. 1-7/8" - 2-1/4" optional.
Cylinder	SmartKey Security or 6-pin removable core.
Faceplate	1" x 2-1/4" round corner, square corner and drive-in collar
Strikes	2.74" x 1.115" round corner and square corner 2.25" x 1.75" 5303 round corner full lip strike (grade 3 when used) Other strikes are available as service parts.
Bolt	1" throw.
Door Handing	Reversible for right or left-hand doors.
ANSI/BHMA	Grade 2 Certified.
ADA	Interior turn pieces are in compliance with the American National Standards Institute (ANSI A117.1) and the Americans with Disabilities Act (ADA).
UL	Meets UL 3 hour fire rating for 782. UL 1/3 hour fire rating available on select SKUs.

**KWIKSET SIGNATURE SERIES  
980/985 DEADBOLTS**

Door Prep	980: Crossbore 2-1/8" or 1-1/2". Edge Bore 1". 982: Crossbore 2-1/8".
Backset	Adjustable 2-3/8" or 2-3/4".
Door Thickness	1-3/8" - 1-3/4" doors standard. 1-7/8" - 2-1/4" optional.
Cylinder	SmartKey Security
Faceplate	1" x 2-1/4" round corner, square corner and drive-in collar
Strikes	2.74" x 1.115" round corner and square corner 2.25" x 1.75" 5303 round corner full lip strike (grade 3 when used) Other strikes are available as service parts.
Bolt	1" throw.
Door Handing	Reversible for right or left-hand doors.
ANSI/BHMA	Grade 1 Certified.
ADA	Interior turn pieces are in compliance with the American National Standards Institute (ANSI A117.1) and the Americans with Disabilities Act (ADA).
UL	Meets UL 3 hour fire rating for 982 UL 1/3 hour fire rating available on select SKUs.

**KWIKSET SIGNATURE SERIES 258 DEADBOLTS**

Door Prep	Cross Bore 2-1/8". Edge Bore 1".
Backset	Adjustable 2-3/8" or 2-3/4".
Door Thickness	1-3/8" - 1-3/4" Standard. Thick door service part available for up to 2'1/4".
Cylinder	Smartkey Security
Faceplate	1" x 2-1/4" round corner, square corner and drive-in collar
Rose	Specify round (Uptown) or square (Downtown) rose.
Strikes	2.74" x 1.115" round corner and square corner 2.25" x 1.75" 5303 round corner full lip strike (grade 3 when used) Other strikes are available as service parts.
Bolt	1" Throw Steel.
ANSI/BHMA	A156.36 Grade 1
ADA	Interior turn pieces are in compliance with the American National Standards Institute (ANSI A117.1) and the Americans with Disabilities Act (ADA).
UL	UL 1/3 hour fire rating available on select SKUs.

**KWIKSET SIGNATURE SERIES HANDLESET**

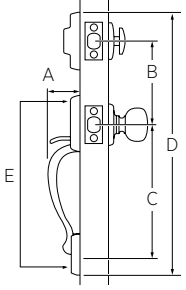

Design	A	B	C	D	E
Arlington*	2-1/2"	5-1/2"	11"	19-1/16"	15"
Austin	3-1/8"	5-1/2"	8-13/32" 9-1/8" 9-11/16"	18-13/32"	13-17/20"
Avalon™	2-7/8"	5-1/2"	8-13/32"	18- 5/32" 12-13/20"	13"
Chelsea*	2-3/16"	5-1/2"	9-11/16"	18 -1/2"	13"
Hawthorne™	2-7/8"	5-1/2"	8-13/32"	17-7/16"	13-2/5"
Prague	2-25/32"	5-1/2"	8-13/32"	17-23/32"	
Prescott	2-25/32"	5-1/2"	8-13/32"	17-23/32"	
San Clemente	2-5/8"	5-1/2"	8-13/32"	17-15/16"	
Tavaris	2-17/32"	5-1/2"	8-13/32"	18"	12-19/25"
Vancouver	2-1/32"	5-1/2"	8-13/32" 9-11/16"	17-15/16"	

**KWIKSET SIGNATURE SERIES KNOBS**

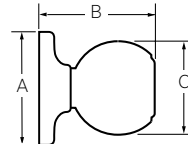

Design	A	B	C
Arroyo	2-5/8"	2-7/16"	2-3/16"
Abbey*	2-5/8"	2-7/16"	2"
Hancock*	2-5/8"	2-1/2"	2-3/8"
Laurel*	2-5/8"	2-7/16"	2-7/16"
Pismo	2-5/8"	2-13/32"	2-6/7"

**KWIKSET SIGNATURE SERIES LEVERS**

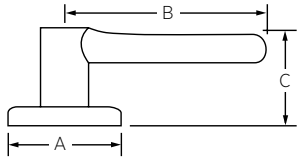

Design	A	B	C	B (Keyed)	C (Keyed)
Halifax	2-5/8"	4-15/32"	2-19/32"		2-3/8"
Katella	2-21/32"	4-1/4"	2-15/32"		2-9/16"
Lisbon	2-5/8"	4-5/32"	2-9/16"		2-3/8"
Milan	2-5/8"	4-5/32"	2-9/16"		2-3/8"
Perth	2-21/32"	4-1/4"	2-7/16"		2-11/32"
Sedona	2-21/32"	4-1/4"	2-17/32"	4-9/32"	2-5/16"
Singapore Square	2-11/16"	4-7/32"	2-1/2"		2-1/4"
Trafford	2-21/32"	4-5/32"	2-19/32"		2-9/16"
Tustin*	2-5/8"	4-7/32"	2-3/32"		2-19/32"
Tripoli	2-11/16"	4-1/14"	2-9/16"		2-9/16"

**KWIKSET SIGNATURE SERIES 158-159 DEADBOLT**

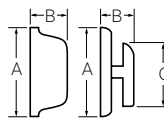

Round Design	A	B	C
158 Interior	2-17/32"	1-13/32"	1-11/16"
158 Exterior	2-17/32"	15/16"	
159 Interior	2-17/32"	1-13/32"	1-11/16"
159 Exterior	2-17/32"	15/16"	

Square Design	A	B	C
158 Interior	2-17/32"	1-13/32"	1-11/16"
158 Exterior	2-19/32"	15/16"	
159 Interior	2-17/32"	1-13/32"	1-11/16"
159 Exterior	2-19/32"	15/16"	

**KWIKSET SIGNATURE SERIES 980-985 DEADBOLT**

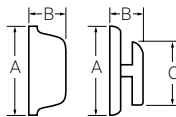

Design	A	B	C
980 Interior	2-19/32"	1-5/32"	1-13/16"
980 Exterior	2-5/8"	1-1/32"	
985 Interior	2-5/8"	1-1/32"	
985 Exterior	2-5/8"	1-1/32"	

**KWIKSET SIGNATURE SERIES 780-785 DEADBOLT**

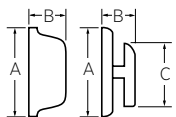

Design	A	B	C
780	2-1/2"	15/16"	1-25/32"
780	2-5/8"	1-1/8"	
785 Interior	2-5/8"	1-1/8"	
785 Exterior	2-5/8"	1-1/8"	

**KWIKSET SIGNATURE SERIES 258 UPTOWN, DOWNTOWN & MIDTOWN**

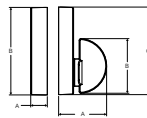

Design	A	B	C
258 Round Interior	1-3/8"	1-21/32"	2-5/8"
258 Round Exterior	9/16"	2-5/8"	

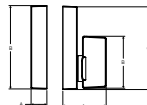

Design	A	B	C
258 Square Interior	1-7/16"	1-21/32"	2-5/8"
258 Square Exterior	1/2"	2-5/8"	

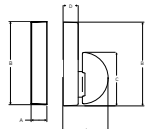

Design	A	B	C	D
258 MDT Interior	1-7/16"	2-11/16"	1-21/32"	1/2"
258 MDT Exterior	1/2"	2-11/16"		

### Trusted Security



- ANSI/BHMA Grade 3
- Easy Installation
- Available with SmartKey® Security
- Most Recognized Styles

### Warranty

- Lifetime Mechanical
- Lifetime Finish



Amador



Bellevue™



Dakota™



Henley



Aliso™



Cove™



Polo®



Tylo®



Balboa™



Breton



Casey



Delta®



Dorian®



660 RDT  
Contemporary



660 SQT  
Deadbolt



660/665  
Deadbolt



Henley



Ladera®

**Amador**



**Belleview™**



**Dakota™**



**Henley**



Amador	Model	Function	Finish							Case	
			3	L03	5	11P	15	26	26D	514	Qty
	687AMD SMT	Single Cylinder					\$189.80	\$189.80	\$171.00	\$199.00	6
	898AMD	Handle Only					\$156.80	\$156.80		\$166.00	6

Belleview™	Model	Function	Finish							Case	
			3	L03	5	11P	15	26	26D	514	Qty
	687BW	Single Cylinder					\$146.20				6
	687BW SMT	Single Cylinder					\$151.20		\$132.40	\$160.50	6

Dakota™	Model	Function	Finish							Case	
			3	L03	5	11P	15	26	26D	514	Qty
	687DA	Single Cylinder				\$146.20	\$146.20				6
	687DA SMT	Single Cylinder			\$132.40	\$151.20	\$151.20		\$132.40	\$160.40	6
	898DA	Handle Only				\$113.20	\$113.20				6

Henley	Model	Function	Finish							Case	
			3	L03	5	11P	15	26	26D	514	Qty
	687HYH SMT	Single Cylinder					\$189.80			\$199.00	6
	898HYH	Handle Only					\$156.80	\$156.80		\$166.00	6

**NOTE:** All 687 handlesets are compatible with the 966 interior packs found on page 33.

	Model	Function	Finish								Case Qty
			3	L03	5	11P	15	26	26D	514	
	200BL	Hall/Closet	\$44.50		\$44.50	\$48.60	\$48.60	\$48.60	\$44.50	\$51.60	20
	200BL	Hall/Closet UL (20 Min FD)					\$51.10				20
	300BL	Bed/Bath	\$47.50		\$47.50	\$51.60	\$51.60	\$51.60	\$47.50	\$54.60	20
	405BL	Keyed Lever				\$67.10	\$67.10		\$63.00		20
	405BL SMT	Keyed Lever	\$68.00		\$68.00	\$72.10	\$72.10	\$72.10	\$68.00	\$75.10	20
	488BL	Half Dummy	\$22.30		\$22.30	\$24.30	\$24.30	\$24.30	\$22.30	\$25.80	20

	Model	Function	Finish								Case Qty
			3	L03	5	11P	15	26	26D	514	
	200BRNL RDT	Hall/Closet					\$53.30	\$53.30		\$56.30	20
	300BRNL RDT	Bed/Bath					\$56.30	\$56.30		\$59.30	20
	405BRNL RDT SMT	Keyed Lever					\$76.80	\$76.80		\$79.80	20
	488BRNL RDT	Half Dummy					\$26.70	\$26.70		\$28.20	20

	Model	Function	Finish								Case Qty
			3	L03	5	11P	15	26	26D	514	
	200BRNL SQT	Hall/Closet					\$53.30	\$53.30		\$56.30	12
	300BRNL SQT	Bed/Bath					\$56.30	\$56.30		\$59.30	12
	405BRNL SQT SMT	Keyed Lever					\$76.80	\$76.80		\$79.80	12
	488BRNL SQT	Half Dummy					\$26.70	\$26.70		\$28.20	12

	Model	Function	Finish								Case Qty
			3	L03	5	11P	15	26	26D	514	
	200CSL RDT	Hall/Closet					\$53.30	\$53.30		\$56.30	20
	200CSL RDT	Hall/Closet UL (20 Min FD)					\$55.80	\$55.80		\$58.80	20
	300CSL RDT	Bed/Bath					\$56.30	\$56.30		\$59.30	20
	405CSL RDT SMT	Keyed Lever					\$76.80	\$76.80		\$79.80	20
	405CSL RDT SMT	Keyed Lever (20 min. FD)					\$79.30				20
	488CSL RDT	Half Dummy					\$26.70	\$26.70		\$28.20	20

	Model	Function	Finish								Case Qty
			3	L03	5	11P	15	26	26D	514	
	200CSL SQT	Hall/Closet					\$53.30	\$53.30		\$56.30	12
	200CSL SQT	Hall/Closet UL (20 Min FD)					\$55.80	\$55.80		\$58.80	20
	300CSL SQT	Bed/Bath					\$56.30	\$56.30		\$59.30	12
	405CSL SQT SMT	Keyed Lever					\$76.80	\$76.80		\$79.80	12
	488CSL SQT	Half Dummy					\$26.70	\$26.70		\$28.20	12

	Model	Function	Finish								Case Qty
			3	L03	5	11P	15	26	26D	514	
	200DL	Hall/Closet				\$48.60	\$48.60	\$48.60	\$44.50		20
	200DL	Hall/Closet UL (20 Min FD)					\$51.10		\$47.00		20
	300DL	Bed/Bath				\$51.60	\$51.60	\$51.60	\$47.50		20
	405DL	Keyed Lever				\$67.10	\$67.10		\$63.00		20
	405DL SMT	Keyed Lever	\$68.00			\$72.10	\$72.10	\$72.10	\$68.00		20
	409DL SMT	Keyed Lever UL (90 Min.)					\$78.10		\$74.00		20
	412DL SMT	Storeroom Keyed Lever UL							\$77.00		20
	420DL	Hall/Closet UL (90 Min.)					\$57.60		\$53.50		20
	462DL	Storeroom Keyed Lever						\$70.10	\$66.00		20
	462DL SMT	Storeroom Keyed Lever						\$75.10	\$71.00		20
	488DL	Half Dummy				\$24.30	\$24.30	\$24.30	\$22.30		20

	Model	Function	Finish								Case Qty
			3	L03	5	11P	15	26	26D	514	
	200DNL	Hall/Closet				\$48.60	\$48.60				20
	300DNL	Bed/Bath				\$51.60	\$51.60				20
	405DNL	Keyed Lever				\$67.10	\$67.10				20
	405DNL SMT	Keyed Lever				\$72.10	\$72.10				20
	420DNL	Hall/Closet UL (3 Hr.)					\$57.60				20
	488DNL	Half Dummy				\$24.30	\$24.30				20





	Model	Function	Finish							Case	
			3	L03	5	11P	15	26	26D	514	Qty
	200HYL	Hall/Closet					\$53.30			\$56.30	20
	300HYL	Bed/Bath					\$56.30			\$59.30	20
	405HYL SMT	Keyed Lever					\$76.80			\$79.80	20
	488HYL	Half Dummy					\$26.70			\$28.20	20

	Model	Function	Finish							Case	
			3	L03	5	11P	15	26	26D	514	Qty
	200LRL RDT	Hall/Closet					\$48.60	\$48.60	\$44.50	\$51.60	20
	300LRL RDT	Bed/Bath					\$51.60	\$51.60	\$47.50	\$54.60	20
	405LRL RDT	Keyed Lever					\$67.10		\$63.00		20
	405LRL RDT SMT	Keyed Lever					\$72.10	\$72.10	\$68.00	\$75.10	20
	488LRL RDT	Half Dummy					\$24.30	\$24.30	\$22.30	\$25.80	20

	Model	Function	Finish							Case	
			3	L03	5	11P	15	26	26D	514	Qty
	200LRL SQT	Hall/Closet					\$48.60	\$48.60	\$44.50	\$51.60	12
	300LRL SQT	Bed/Bath					\$51.60	\$51.60	\$47.50	\$54.60	12
	405LRL SQT SMT	Keyed Lever					\$72.10	\$72.10	\$68.00	\$75.10	12
	488LRL SQT	Half Dummy					\$24.30	\$24.30	\$22.30	\$25.80	12

	Model	Function	Finish							Case	
			3	L03	5	11P	15	26	26D	514	Qty
	200AO	Hall/Closet					\$33.00				30
	300AO	Bed/Bath					\$36.20				30
	400AO SMT	Entry					\$47.50				30
	488AO	Half Dummy					\$16.50				20

	Model	Function	Finish							Case	
			3	L03	5	11P	15	26	26D	514	Qty
	200CV	Hall/Closet				\$33.00	\$33.00			\$36.00	30
	300CV	Bed/Bath				\$36.20	\$36.20			\$39.20	30
	400CV	Entry				\$42.50	\$42.50				30
	400CV SMT	Entry				\$47.50	\$47.50			\$50.50	30
	488CV	Half Dummy				\$16.50	\$16.50			\$18.00	20

	Model	Function	Finish							Case	
			3	L03	5	11P	15	26	26D	514	Qty
	200P	Hall/Closet			\$26.50	\$29.50	\$29.50	\$29.50	\$26.50		30
	300P	Bed/Bath			\$29.70	\$32.70	\$32.70	\$32.70	\$29.70		30
	400P	Entry			\$39.20	\$42.20	\$42.20		\$39.20		30
	400P SMT	Entry			\$44.20	\$47.20	\$47.20	\$47.20	\$44.20		30
	450P SMT	Storeroom							\$47.20		30
	488P	Half Dummy			\$13.30	\$14.80	\$14.80	\$14.80	\$13.30		20

	Model	Function	Finish							Case	
			3	L03	5	11P	15	26	26D	514	Qty
	200T	Hall/Closet	\$24.10		\$24.10		\$27.10	\$27.10	\$24.10		30
	300T	Bed/Bath	\$27.30		\$27.30		\$30.30	\$30.30	\$27.30		30
	400T	Entry	\$33.60		\$33.60		\$36.60	\$36.60	\$33.60		30
	400T SMT	Entry	\$38.60		\$38.60		\$41.60	\$41.60	\$38.60		30
	488T	Half Dummy	\$12.10		\$12.10		\$13.60	\$13.60	\$12.10		20

**660/663 RDT**



Model	Function	Finish								Case Qty
		3	L03	5	11P	15	26	26D	514	
660 RDT	Single Cylinder SMT					\$50.30	\$50.30	\$47.30	\$53.30	12

**660/663 SQT**



Model	Function	Finish								Case Qty
		3	L03	5	11P	15	26	26D	514	
660 SQT	Single Cylinder SMT					\$50.30	\$50.30	\$47.30	\$53.30	12
660 SQT	Single Cylinder SMT UL (20 Min. FD)					\$52.80			\$55.80	12
663 SQT	Single Sided					\$28.20	\$28.20	\$26.50	\$29.80	12
663 SQT	Single Sided UL (3 Hr.)					\$34.20	\$34.20	\$32.50	\$35.80	12

**660/665**



Model	Function	Finish								Case Qty
		3	L03	5	11P	15	26	26D	514	
660	Single Cylinder	\$34.70		\$34.70	\$37.70	\$37.70	\$37.70	\$34.70	\$40.70	12
660 SMT	Single Cylinder SMT	\$39.70		\$39.70	\$42.70	\$42.70	\$42.70	\$39.70	\$45.70	12
660 SMT	Single Cylinder SMT UL (20 Min FD)					\$45.20	\$45.20	\$42.20	\$48.20	12
665	Double Cylinder	\$43.90		\$43.90	\$46.90	\$46.90		\$43.90		12
665 SMT	Double Cylinder SMT	\$48.90		\$48.90	\$51.90	\$51.90	\$51.90	\$48.90	\$54.90	12

**One-Sided**



Model	Function	Finish								Case Qty
		3	L03	5	11P	15	26	26D	514	
663	Thumbturn One Side					\$21.10	\$21.10	\$19.40	\$22.80	12
663 UL	Thumbturn One Side UL					\$27.10	\$27.10	\$25.40	\$28.80	12
664	Retrofit Kit for 663	\$13.90			\$15.10	\$15.10		\$13.90		12
667	Thumbturn One Side with Exterior Plate				\$37.70	\$37.70				12

**Deadbolt and Knob Combo Packs**



Model	Function	Finish								Case Qty
		3	L03	5	11P	15	26	26D	514	
690T	Keyed Entry Tylo Knob with Single Cylinder Deadbolt	\$61.50				\$66.90		\$61.50		6
690T SMT	Keyed Entry Tylo Knob with Single Cylinder Deadbolt	\$70.50		\$70.50		\$75.90		\$70.50		6
690P	Keyed Entry Polo Knob with Single Cylinder Deadbolt					\$71.00				6

**Gatelatch**



Model	Function	Finish								Case Qty
		3	L03	5	11P	15	26	26D	514	
599	Double Cylinder SMT							\$43.90		6

## KWIKSET HANDLESETS

Door Prep	<b>Deadbolt:</b> Crossbore 2-1/8" or 1-1/2". Edge Bore 1". <b>Handle:</b> Crossbore 2-1/8". Edge Bore 1".
Backset	<b>Deadbolt:</b> Adjustable to 2-3/8" or 2-3/4". <b>Handle:</b> Adjustable to 2-3/8" or 2-3/4".
Door Thickness	1-3/4" doors standard. 2-1/4" doors optional. Not designed for use on 1-3/8" doors.
Cylinder	SmartKey Security or traditional 5-Pin, Pin & Tumbler.
Faceplate	1" x 2-1/4" round corner. Other options available as service parts.
Strikes	<b>Deadbolt:</b> 1" x 2-1/4" round corner. Other options available as service parts <b>Handle:</b> 2-1/4" round corner full lip. Other options available as service parts.
Bolt	<b>Deadbolt:</b> 1" throw. <b>Handle:</b> 1/2" throw.
Door Handing	Reversible for right or left-hand doors.
ANSI/BHMA	Deadbolt is Grade 3 Certified.
ADA	N/A
UL	N/A

## KWIKSET LEVERS

Door Prep	Cross Bore 2-1/8". Edge Bore 1".
Backset	Adjustable to 2-3/8" or 2-3/4". UL 2-3/4" standard 2-3/8" optional.
Door Thickness	1-3/8" – 1-3/4" doors standard. 2-1/4" doors optional on 200 and 400 functions only.
Cylinder	SmartKey Security or Pin & Tumbler.
Faceplate	1" x 2-1/4" round corner, square corner and drive-in collar.
Strikes	1" x 2-1/4" round corner. Other options available.
Bolt	1/2" throw.
Door Handing	Specify handing for dummy and interior pack levers.
ANSI/BHMA	Grade 3 Certified. (all functions except 488)
ADA	Functions 200 and 420 in compliance with the American National Standards Institute (ANSI A117.1) and the Americans with Disabilities Act (ADA).
UL	Meets UL 3 hour fire rating for 409, 412, 420 Optional UL 1/3 hour fire rating on select SKUs.

## KWIKSET DEADBOLTS

Door Prep	660, 665: Crossbore 2-1/8". Edge Bore 1". 663: Crossbore 1-5/8". Edge Bore 1". 667: Crossbore 2-1/8" or 1-1/2". Edge Bore 1".
Backset	660, 665, 667: Adjustable latch standard. 663: 2-3/8" standard. 2-3/4" optional.
Door Thickness	660, 663, 665, 667: 1-3/8" – 1-3/4" doors standard.
Cylinder	660, 665: SmartKey Security or Pin & Tumbler.
Faceplate	1" x 2-1/4". Specify round corner, square corner or drive-in.
Strikes	1" x 2-1/4". Specify round corner or square corner. Other options available.
Bolt	1" throw.
Door Handing	Reversible for right or left-hand doors.
ANSI/BHMA	Grade 3 Certified.
ADA	Interior turn pieces are in compliance with the American National Standards Institute (ANSI A117.1) and the Americans with Disabilities Act (ADA).
UL	Meets UL 3 hour fire rating for 663 Optional UL 1/3 hour fire rating on select SKUs.

## KWIKSET KNOBS

Door Prep	Cross Bore 2-1/8". Edge Bore 1".
Backset	Adjustable to 2-3/8" or 2-3/4". 5" available as service part
Door Thickness	1-3/8" – 1-3/4" doors standard. 2-1/4" doors optional on 200 and 400 models only.
Cylinder	SmartKey Security or Pin & Tumbler.
Faceplate	1" x 2-1/4" round corner, square corner and drive-in collar.
Strikes	1" x 2-1/4" round corner. Other options available.
Bolt	1/2" throw.
Door Handing	Reversible for right or left hand doors.
ANSI/BHMA	Grade 3 Certified. (all functions except 488)
ADA	N/A
UL	N/A

**KWIKSET HANDLESET**

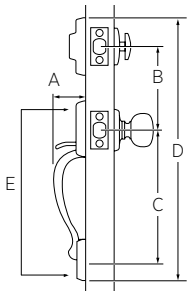

Design	A	B	C	D	E
Amador	2-5/32"	5-1/2"	9-11/16"	17-15/32"	12-14/28"
Belleview™	2-5/32"	5-1/2"	8-13/32"	18-1/16"	12-1/10"
Dakota™	2-5/32"	5-1/2"	8-13/32"	17-3/16"	12-1/10"
Henley	4-5/32"	5-1/2"	8-13/32"	17-5/8"	12-1/4"

**KWIKSET KNOB**

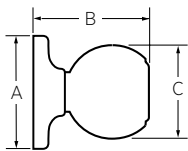

Design	A	B	C
Aliso™	2-5/8"	2-3/4"	2-2/5"
Cove™	2-5/8"	2-1/2"	2-3/16"
Polo™	2-5/8"	2-23/32"	1-7/8"
Tylo™	2-5/8"	2-1/2"	1-7/8"

**KWIKSET LEVER**

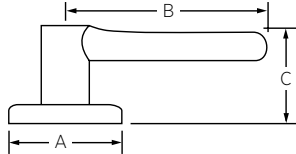

Design	A	B	C	C (Keyed)	Design	A	B	C	C (Keyed)
Balboa™	2-5/8"	4-7/32"	1-15/16"	2-13/32"	Dorian*	2-5/8"	3-3/4"	2-1/8"	2-11/16"
Breton	2-5/8"	4"	2-7/16"	2-15/32"	Henley	2-5/8"	4-3/32"	2-9/16"	2-19/32"
Casey	2-5/8"	4-1/10"	2-3/5"	2-7/16"	Ladera*	2-5/8"	4-3/16"	1-7/8"	2-7/16"
Delta*	2-5/8"	3-5/8"	1-7/8"	2-15/32"					

**KWIKSET DEADBOLT**

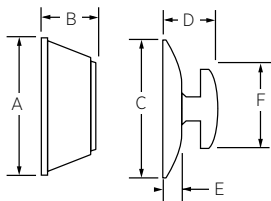

Design	A	B	C	D	E	F
660	2-7/16"	1-1/16"	2-1/2"	2-7/32"	5/16"	1-3/4"
660RDT	2-7/16"	1-1/16"	2-1/2"	3-1/32"	1-3/4"	
660SQT	2-7/16"	1-1/16"	2-1/2"	3-1/32"	1-3/4"	
663		2-1/2"	2-7/32"	5/16"	1-3/4"	
663SQT	2-7/16"	1-1/16"	2-1/2"	3-1/32"	1-3/4"	
665	2-7/16"	1-1/16"	2-1/2"	1-1/16"		
667	2-17/32"	3/8"	2-1/2"	2-7/32"	5/16"	1-3/4"

# SMART LOCKS AND KEYLESS ENTRY LOCKS

Kwikset's electronic door locks offer users the convenience of keyless entry, virtually eliminating the need for keys. All of our electronic locks are easy to install and program while complementing any Kwikset knob, lever or handleset.



## Features



- Smart Locks Replace any Deadbolt for Keyless Entry Convenience
- SmartCode™ Lever Ideal for - Small/Home Office, Utility/Storage Room, Interior Garage/ Side Door
- Lock Your Door with the Touch of a Button
- Customizable Access Codes for Increased Security
- Back-Lit Keypad for Increased Visibility
- Customizable Automatic Door Locking After 30 Seconds for Peace Of Mind
- Installs In Minutes with Just a Screwdriver - No Hard Wiring Required
- Fits Standard Doors ( 1 3/8" - 2" ) with No Screw Holes Required

## Warranty

- 1 Year Electronic Warranty
- Lifetime Finish & Mechanical Warranty

**Kwikset**



**HALO**<sup>TM</sup>



**TOUCH**

FINGERPRINT SMART LOCK

The Halo Touch Wi-Fi enabled smart lock with fingerprint access technology allows you to simply use your unique fingerprint to lock and unlock your door.



Wi-Fi Enabled



Works with the Kwikset App



**HALO**<sup>TM</sup>

WI-FI ENABLED SMART LOCKS

Halo smart locks connect directly to your existing home Wi-Fi network and smartphone to create a simple and secure smart home, without a third-party hub, panel or subscription service.

Halo Wi-Fi Enabled Smart Locks	Model	Function	Finish				Case Qty
			11P	15	26	514	
	939 Halo Touchscreen	WiFi Enabled Deadbolt	\$504.00	\$504.00	\$504.00	\$504.00	1
	938 Halo Touchpad	WiFi Enabled Deadbolt	\$438.00	\$438.00			1
	959 Halo Touch Traditional	WiFi Enabled Deadbolt	\$517.00	\$517.00			1
	959 Halo Touch Contemporary	WiFi Enabled Deadbolt		\$517.00		\$517.00	1

How it Works

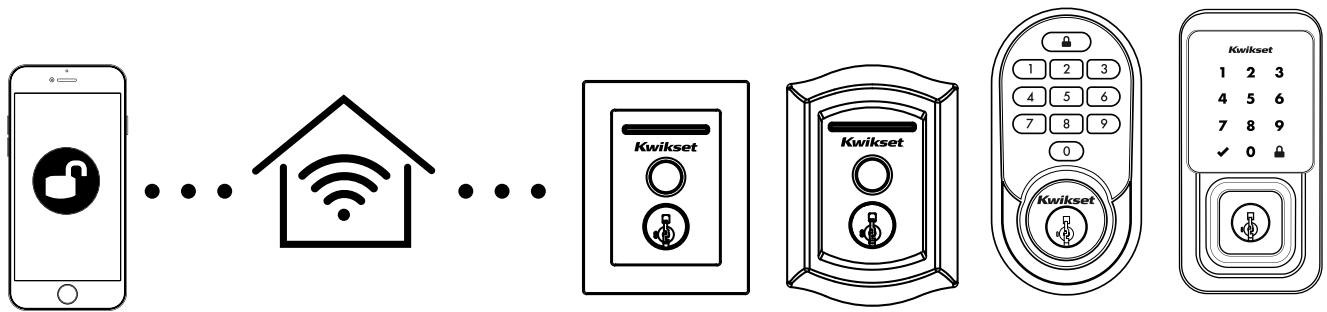

Control your lock from your smartphone



REMOTE ACCESS



PUSH NOTIFICATIONS



EVENT HISTORY



MANAGE ACCESS CODES



MANAGE MULTIPLE HOMES



**SmartCode™  
260 TRL**

**SmartCode™  
260 CNT**

**SmartCode™  
270 TRL**

**SmartCode™  
270 CNT**

**SmartCode™ 260  
TRL**

SKU	Function	Finish								Case
		3	L03	5	11P	15	26	26D	514	Qty
992600-001	9260 TRL L03 SMT RBP RCALFD		\$231.00							2
992600-002	9260 TRL 15 SMT RBP RCALF					\$231.00				2
992600-003	9260 TRL 11P SMT RBP RCALFD				\$231.00					2

**SmartCode™ 260  
CNT**

SKU	Function	Finish								Case
		3	L03	5	11P	15	26	26D	514	Qty
992600-004	9260 CNT 15 SMT RBP RCALFD					\$231.00				2
992600-005	9260 CNT 26 SMT RBP RCALFD						\$231.00			2
992600-006	9260 CNT 514 SMT RBP RCALFD								\$231.00	2

**SmartCode™ 270  
TRL**

SKU	Function	Finish								Case
		3	L03	5	11P	15	26	26D	514	Qty
992700-002	9270 TRL 15 SMT RBP RCALFD					\$275.00				2
992700-003	9270 TRL 11P SMT RBP RCALFD				\$275.00					2

**SmartCode™ 270  
CNT**

SKU	Function	Finish								Case
		3	L03	5	11P	15	26	26D	514	Qty
992700-004	9270 CNT 15 SMT RBP RCALFD					\$275.00				2
992700-005	9270 CNT 514 SMT RBP RCALFD								\$275.00	2





**Aura™**

**SmartCode™  
917 TNL**

**SmartCode™  
917 HFL**

**Powerbolt  
240 TRL**

**Powerbolt  
240 CNT**

**Powerbolt  
250 TRS**

Model	Description	Finish					Case			
		3	L03	5	11P	15	26	26D	514	Qty
942 BLE	Touchscreen Electronic Deadbolt				\$328.00	\$328.00			\$328.00	1

**SmartCode™ 917  
TNL**

Model	Description	Finish					Case			
		3	L03	5	11P	15	26	26D	514	Qty
917 TNL	Touchpad Electronic Lever Tustin				\$262.00	\$262.00				2

**SmartCode™ 917  
HFL**

Model	Description	Finish					Case			
		3	L03	5	11P	15	26	26D	514	Qty
917 HFL	Touchpad Electronic Lever Halifax					\$262.00	\$262.00		\$262.00	2

**Powerbolt  
240 TRL**

Model	Description	Finish					Case			
		3	L03	5	11P	15	26	26D	514	Qty
992400-001	9240 TRL L03 RBP 4AL RCS		\$100.00							2
992400-002	9240 TRL 15 RBP 4AL RCS					\$100.00				2
992400-003	9240 TRL 11P RBP 4AL RCS				\$100.00					2

**Powerbolt  
240 CNT**

Model	Description	Finish					Case			
		3	L03	5	11P	15	26	26D	514	Qty
992400-004	9240 CNT 15 RBP 4AL RCS					\$100.00				2
992400-005	9240 CNT 514 RBP 4AL RCS								\$100.00	2

**Powerbolt  
250 TRS**

Model	Description	Finish					Case			
		3	L03	5	11P	15	26	26D	514	Qty
992500-001	9250 TRS L03 SMT RBP 4AL RCS		\$143.00							2
992500-002	9250 TRS 15 SMT RBP 4AL RCS					\$143.00				2
992500-003	9250 TRS 11P SMT RBP 4AL RCS				\$143.00					2
992500-004	9250 TRS 514 SMT RBP 4AL RCS								\$143.00	2

 **HOME  
CONNECT™**  
ELECTRONIC SMART LOCKS

Control your lock from anywhere on your smart phone, tablet, or internet connected device and never worry about forgetting to lock your door again.

- Remotely lock and unlock your door from anywhere
- Receive notifications of your lock's activity
- Control when others have access to your home
- Arm or disarm your security panel
- Wirelessly communicate to other devices in your home



## Features

- Full 128-Bit Encryption Security
- Motorized locking mechanism enables true remote locking & unlocking
- SmartKey Security - providing superior security against advanced break-in techniques.
- Easy Integration
- Z-Wave Wireless Protocol
- Fits Standard Doors (1 3/8"-2") with No Screw Holes Required
- 4 AA Alkaline Batteries (no hard wiring) - batteries last for approximately 1 year

### Electronic Locks with Home Connect (Z-Wave)

Item Number	Function	Finish						Case Qty.	Price
		LO3	11P	15	26	26D	514		
<b>HomeConnect 620 Traditional</b>		LO3	11P	15	26	26D	514		
98930-001	HC620 TRL ZW700 15 SMT RCALFD RCS BP			•				1	\$297.00
98930-002	HC620 TRL ZW700 11P SMT RCALFD RCS BP		•					1	\$297.00
98930-003	HC620 TRL ZW700 LO3 SMT RCALFD RCS BP	•						1	\$297.00

\*Product must be ordered by item number and not description

Item Number	Function	Finish						Case Qty.	Price
		LO3	11P	15	26	26D	514		
<b>HomeConnect 620 Contemporary</b>		LO3	11P	15	26	26D	514		
98930-004	HC620 CNT ZW700 15 SMT RCALFD RCS BP			•				1	\$297.00
98930-005	HC620 CNT ZW700 11P SMT RCALFD RCS BP		•					1	\$297.00
98930-006	HC620 CNT ZW700 26 SMT RCALFD RCS BP				•			1	\$297.00
98930-007	HC620 CNT ZW700 514 SMT RCALFD RCS BP						•	1	\$297.00

\*Product must be ordered by item number and not description

Item Number	Function	Finish						Case Qty.	Price
		LO3	11P	15	26	26D	514		
<b>SmartCode™ 916 Contemporary with Home Connect</b>		LO3	11P	15	26	26D	514		
99160-041	916CNT 500 15 SMT CP TPR RCALFD V2			•				1	\$506.00
99160-042	916CNT 500 11P SMT CP TPR RCALFD V2		•					1	\$506.00
99160-043	916CNT 500 26 SMT CP TPR RCALFD V2				•			1	\$506.00
99160-044	916CNT 500 514 SMT CP TPR RCALFD V2						•	1	\$506.00

\*Product must be ordered by item number and not description

Item Number	Function	Finish						Case Qty.	Price
		LO3	11P	15	26	26D	514		
<b>SmartCode™ 916 with Home Connect</b>		LO3	11P	15	26	26D	514		
99160-038	916TRL 500 15 SMT CP TPR RCALFD V2			•				1	\$506.00
99160-039	916TRL 500 11P SMT CP TPR RCALFD V2		•					1	\$506.00

\*Product must be ordered by item number and not description

Item Number	Function	Finish						Case Qty.	Price
		LO3	11P	15	26	26D	514		
<b>SmartCode™ 912 with Home Connect</b>		LO3	11P	15	26	26D	514		
99120-037	912TNL ZW500 15 RCALFD			•				1	\$413.00
99120-038	912TNL ZW500 11P RCALFD		•					1	\$413.00

\*Product must be ordered by item number and not description



### Halo™, Halo™ Touch

Function	Single cylinder deadbolt
Door Prep	2 1/8" diameter bore hole & 1" diameter latch hole
Backset	Adjustable 2 3/8" or 2 3/4"
Door Thickness	1 3/8" - 2" automatic adjustment
Faceplates	1" x 2 1/4" round corner standard
Strikes	Round corner, 4 hole strike, 2 3/4" x 1 1/8"
Latch	Round corner adjustable 2 3/8" x 2 3/4"
Bolt	1" throw, steel deadbolt
Door Handing	Reversible
Cylinder	SmartKey Security™

### SMARTCODE™ 912 LEVER

Door Prep	2-1/8" diameter face hole & 1" diameter latch hole
Backset	Adjustable to 2-3/8" or 2-3/4"
Door Thickness	1-3/8" to 2" automatic adjustment
Cylinder	SmartKey Security
Faceplate	1" x 2-1/4". Round corner standard
Strikes	2-1/4" full lip. Round corner
Bolt	1/2" throw
Door Handing	Reversible
Batteries	4 AA Alkaline
Wireless Communication	Z-Wave wireless technology
Operation	908.42 MHz (US)
Range	Typical 100ft line of sight

### HomeConnect™ 620

<b>Electrical:</b>	
Input Power	6V (4 x AA alkaline batteries)
<b>Mechanical:</b>	
Door Prep	1 1/2" & 2 1/8" diameter bore hole & 1" deep latch hole
Backset	Adjustable 2 3/8" or 2 3/4"
Door Thickness	1 3/8" - 2" automatic adjustment
Faceplates	1" x 2 1/4" round corner standard
Strikes	Round corner strike 1 1/8" x 2 3/4"
Latch	Round corner adjustable 2 3/8" x 2 3/4"
Bolt	1" throw, steel deadbolt
Door Handing	Reversible
Cylinder	SmartKey® Keyway
<b>Environmental:</b>	
Temperature Range	Exterior: -40°F to 150°F Interior: 32°F to 140°F

### SMARTCODE™ 916

Function	Single cylinder deadbolt
Door Prep	2-1/8" or 1-1/2" diameter face hole & 1" diameter latch hole
Backset	Adjustable to 2-3/8" or 2-3/4"
Door Thickness	1-3/8" to 2-1/8" automatic adjustment
Cylinder	SmartKey Security
Faceplates	1" x 2-1/4" round corner standard
Strikes	Round corner, 4 hole strike, 2-3/4" x 1-1/8"
Latch	Round corner adjustable 2-3/8" or 2-3/4"
Bolt	1" throw, steel deadbolt
Door Handing	Reversible
Batteries	4 AA Required
Wireless Communication	Z-Wave wireless technology
Operation	908.42 MHz (US)
Range	Typical 100ft line of sight

**AURA™ DEADBOLT**

Door Prep	2-1/8" diameter face hole & 1" diameter latch hole
Backset	Adjustable to 2-3/8" or 2-3/4"
Door Thickness	1-3/8" to 2" automatic adjustment
Cylinder	SmartKey Security
Faceplate	1" x 2-1/4". Round corner standard
Strikes	2-3/4" x 1-1/8". Round corner 4 hole strike
Bolt	1" throw
Door Handing	Reversible
Batteries	4 AA Alkaline

**POWERBOLT 240/250**

Power	6V, 4 x AA alkaline batteries, 12-month battery life (batteries not included)
Door Prep	1-1/2" or 2-1/8" diameter cross bore hole and 1" diameter edge bore hole
Latch Backset	Adjustable 2-3/8" or 2-3/4"
Door Thickness	1-3/8" to 1-3/4" standard. Service part available for 2-1/4" thick doors.
Faceplates	1" x 2-1/4" round corner faceplate with drive-in collar standard
Strike	2-3/4" x 1-1/8" round corner 2-hole strike
Bolt	1" throw, steel bolt
Door Handing	Reversible for right or left-hand doors
Cylinder (240)	KW1 P&T cylinder
Cylinder (250)	SmartKey Security™ KW1 cylinder
UL Rated	N/A
Security	Deadbolt: A156.36 Grade 3 Certified
Temperature Range	Exterior: -40F to 150F, Interior: 32F to 130F
Humidity	Exterior: 100% condensing, Interior: 30% to 95% non-condensing
Warranty	Lifetime Limited Mechanical and Finish Warranty One Year Limited Electronics Warranty

**SMARTCODE™ 917**

Function	Keyed entry electronic lever
Door Prep	Cross Bore 2- 1/8". Edge Bore 1".
Backset	2 3/8" or 2 3/4"
Door Thickness	1 3/8" - 1 3/4"
Faceplates	1" x 2 1/4" round corner standard, drive in available
Strikes	2 1/4" full lip round corner
Latch	Adjustable 2 3/8" x 2 3/4"
Bolt	1/2" throw, dead latch
Door Handing	Reversible for right or left-handed doors
Cylinder	SmartKey Security™
UL Rating	20 min
Temperature Range	Exterior: -40F to 150F Interior: 32F to 130F
Humidity	Exterior: - 100% condensing Interior: 30% - 95% non-condensing

**SMARTCODE™ 260/270**

Battery	Uses 4 x AA 6V alkaline cell batteries with approximately 1 year battery life
Function	Single cylinder deadbolt
Door Prep	1 1/2" (38mm) or 2 1/8" (54mm) diameter cross bore hole and 1" diameter edge bore hole
Backset	Adjustable 2 3/8" (60mm) or 2 3/4" (70mm)
Door Thickness	1 3/8" (35mm) to 1 3/4" (44mm) standard. Thick door service part available for 2-1/4" (57mm) thick doors
Faceplates	1" (25 mm) x 2 1/4" (57 mm) round corner faceplate with drive-in collar standard
Strikes	2 3/4" (70mm) x 1 1/8" (29mm) round corner 4 hole strike
Bolt	1" (25mm) throw, steel bolt with anti-saw security pin
Door Handing	Reversible
Cylinder	SmartKey Security™ with 2 KW1 keys
Temperature Range	Exterior: -40°F to 150°F (-40°C to 66°C) Interior: 32°F to 130°F (0°C to 54°C)
Humidity	Exterior: 100% condensing Interior: 30% to 95% non-condensing
Codes	Up to 50 user codes and 10 one-time user codes with optional programming code

**AURA**

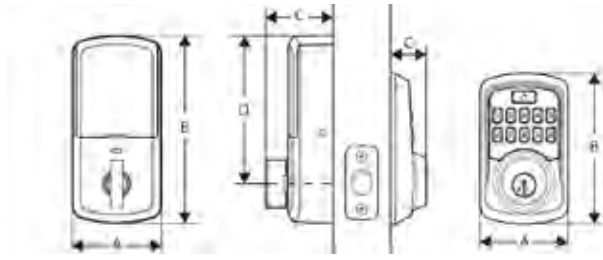

Design	A	B	C	D
Outer Trim	2 3/4"	5 13/16"	2 1/8"	4 9/16"
Inner Trim	2 23/32"	4 5/8"	1 3/16"	---

**HALO TOUCH**

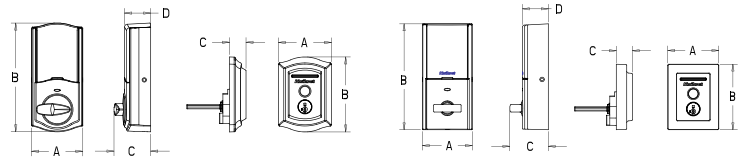

TRL	A	B	C	D	CNT	A	B	C	D
Interior	2 22/32"	5 25/32"	1 15/16"	1 7/16"	Interior	2 22/32"	5 25/32"	2 2/32"	1 13/32"
Exterior	2 13/16"	3 31/32"	7/8"	---	Exterior	2 28/32"	3 9/16"	7/8"	---

**HALO TOUCHSCREEN**

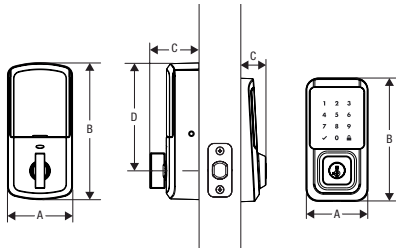

Design	A	B	C	D
Interior	2 3/4"	5 13/16"	2 1/8"	4 9/16"
Exterior	2 28/32"	5 5/8"	1 3/16"	---

**HALO KEYPAD**

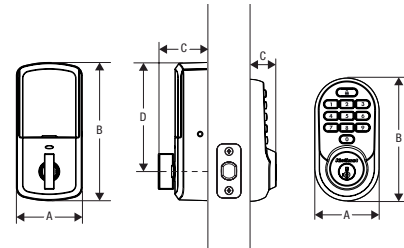

Design	A	B	C	D
Interior	2 3/4"	5 13/16"	2 1/8"	4 9/16"
Exterior	2 28/32"	5 15/32"	1 3/16"	---

**SMARTCODE™ 917 TNL**

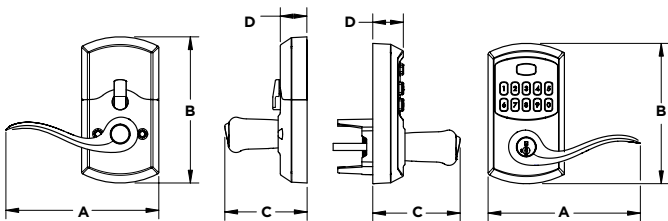

Design	A	B	C	D
Outer Trim	5 9/32"	5 5/32"	3 3/32"	1 1/8"
Inner Trim	5 5/8"	5 3/8"	2 29/32"	3 1/32"

**SMARTCODE™ 917 HNL**

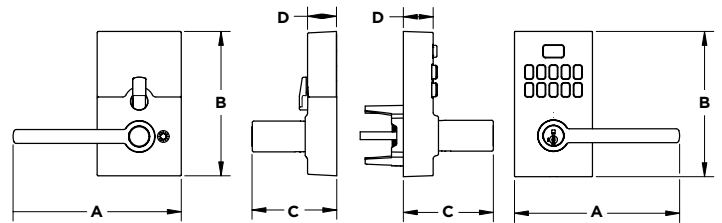

Design	A	B	C	D
Outer Trim	5 9/16"	4 29/32"	3 1/32"	1"
Inner Trim	5 1/32"	4 7/8"	2 27/32"	3 1/32"

**SMARTCODE™ 916**

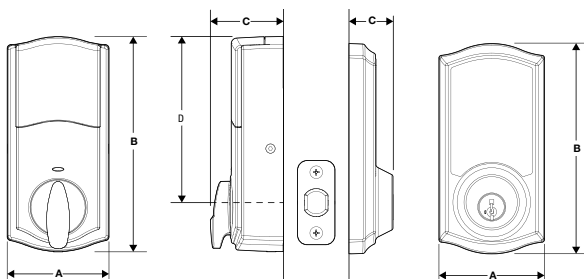

Design	A	B	C	D
Outer Trim	2-13/16"	5-3/8"	1-3/16"	
Inner Trim	2-3/4"	5-3/4"	1-15/16"	4-9/16"

**SMARTCODE™ 916 CNT**

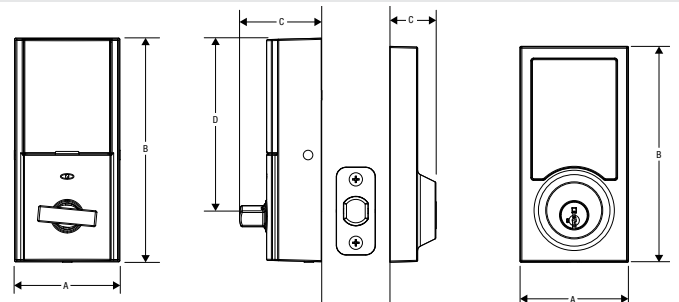

Design	A	B	C	D
Outer Trim	2 11/16"	5 3/4"	2 3/32"	4 9/16"
Inner Trim	2 25/32"	5 7/32"	1 13/16"	---

**SMARTCODE™ 912**

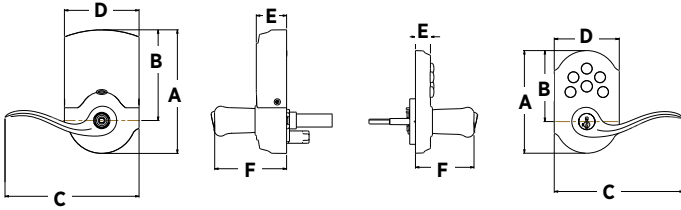

Design	A	B	C	D	E	F
Outer Trim	4 7/16"	3 1/16"	5 19/32"	2 13/16"	2 1/32"	2 17/32"
Inner Trim	5 11/32"	3 15/16"	5 13/16"	3 1/4"	1 5/16"	3 1/8"

**SMARTCODE™ 260 TRL**

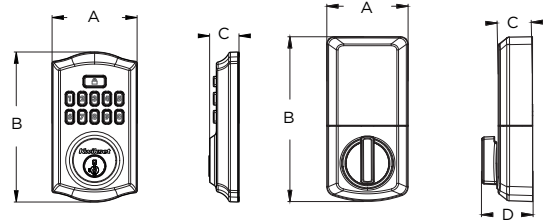

Design	A	B	C	D
Outer Trim	2 13/16"	5"	1"	
Inner Trim	2 3/4"	5 1/2"	1 1/8"	1 1/16"

**SMARTCODE™ 260 CNT**

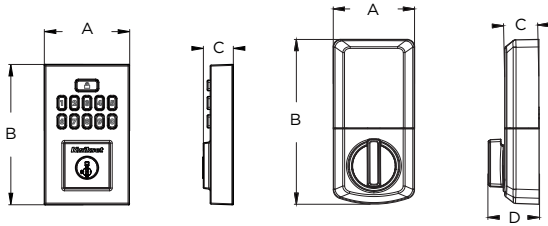

Design	A	B	C	D
Outer Trim	2 3/4"	4 9/16"	1"	
Inner Trim	2 3/4"	5 1/2"	1 1/8"	1 11/16"

**SMARTCODE™ 270 TRL**

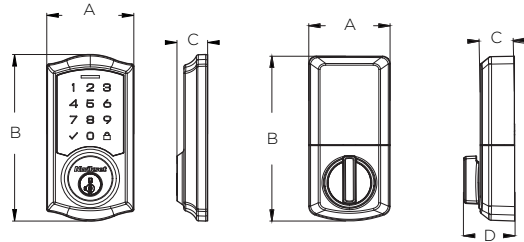

Design	A	B	C	D
Outer Trim	2 3/4"	5 3/16"	1"	
Inner Trim	2 3/4"	5 1/2"	1 1/8"	1 11/16"

**SMARTCODE™ 270 CNT**

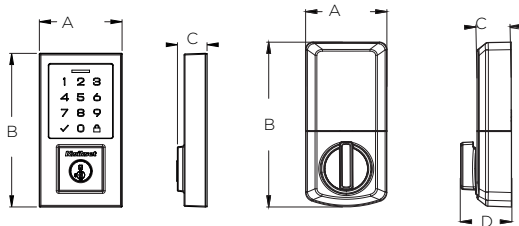

Design	A	B	C	D
Outer Trim	2 3/4"	5 3/16"	1"	
Inner Trim	2 3/4"	5 1/2"	1 1/8"	1 11/16"

**POWERBOLT™ 250 TRS**

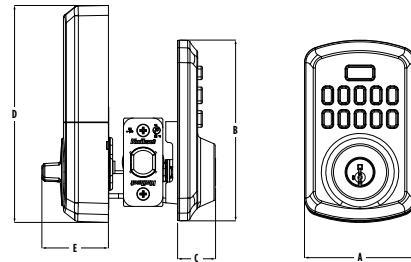

Design	A	B	C	D	E
250 TRS	2 13/16"	4 19/32"	3 1/32"	5 1/2"	1 11/16"

**POWERBOLT 240 CNT**

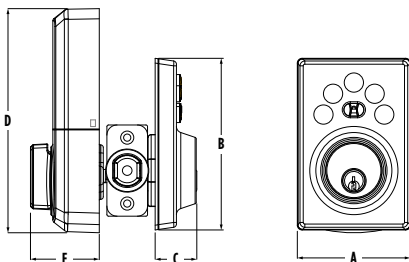

Design	A	B	C	D	E
240 TRL	2 25/32"	4 7/32"	1 1/32"	5 1/2"	1 11/16"

**POWERBOLT 240 TRL**

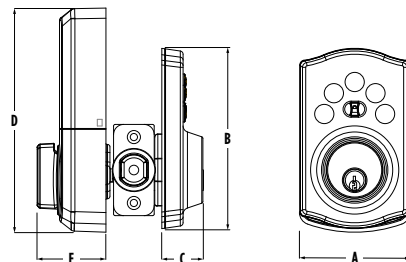

Design	A	B	C	D	E
240 TRL	2 25/32"	4 7/16"	1 1/32"	5 1/2"	1 11/16"

1666075-01/24

## KEY CONTROL™ D E A D B O L T

### THE SMART ALTERNATIVE TO MASTER KEYING IN A NEW CONTEMPORARY STYLE

Re-keying & managing a traditional master key system is labor intensive, time consuming & costly. With the first & only two cylinder Key Control Deadbolt, either cylinder can be re-keyed in seconds, without removing the lock from the door.

#### Key Control

- Two separate cylinders, Tenant & Property Manager, allows for more tenant key cuts than a traditional master key system
- New proprietary keyway adds security - the tenant key will never fit into the Property Manager Cylinder
- The Property Manager Cylinder is concealed when not in use to avoid tenant confusion

#### Increased Efficiency

- Re-key the lock without removing from the door
- Save time & money by re-keying yourself
- Maintain key control throughout tenant and employee turnover



*Perfect for multi-family dwellings, student housing, assisted living & rental properties.*

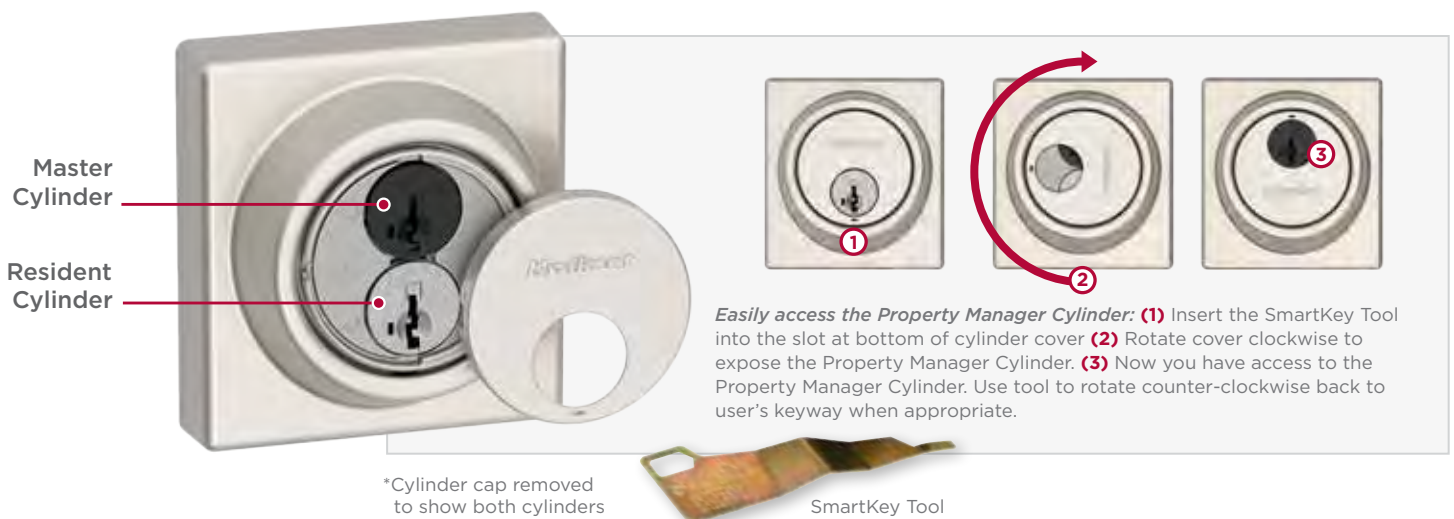



**Interconnect Levers - 780 Deadbolt**

	Model	Function	Style	Finish							
				3	L03	5	11P	15	26	26D	514
	508 SMT	Passage (3 Hr. UL)	Tustin	\$252.30				\$257.30			
			Kingston				\$257.30		\$252.30	\$261.30	
	508	Passage (3 Hr. UL)	Kingston						\$252.30	\$261.30	

**Interconnect Key Control Deadbolt**

	Model	Function	Style	Finish							
				3	L03	5	11P	15	26	26D	514
	508 SMT KCDB	Passage (3 Hr. UL)	Kingston					\$264.30			\$268.40

**Contemporary Interconnect Levers - 780 Deadbolt**

	Model	Function	Style	Finish							
				3	5	11P	15	26	26D	514	
	508 SMT	Passage (3 Hr. UL)	Hali RDT CNT				\$275.30	\$275.30		\$279.60	

**Contemporary Interconnect Levers - KCDB**

	Model	Function	Style	Finish							
				3	5	11P	15	26	26D	514	
	508 SMT KCDB	Passage (3 Hr. UL)	Hali SQT CNT				\$282.30	\$282.30		\$286.30	

**Key Control  
Deadbolt**



Model	Function	Finish								Case
		3	L03	5	11P	15	26	26D	514	Qty
817 SMT	Key Control Deadbolt UL (3 Hr.)	\$80.90			\$88.90	\$88.90		\$80.90	\$91.90	12
817 SMT SQT UL	Key Control Deadbolt UL (3 Hr.)					\$88.90			\$91.90	12

**SmartCode™ 955**





Model	Description	Finish								Case
		3	L03	5	11P	15	26	26D	514	Qty
955	Touchpad Electronic Lever				\$237.00	\$237.00		\$237.00	\$237.00	2

## GRADE 2 LEVERS

<b>Kingston™</b>	<b>Model</b>	<b>Function</b>	<b>Finish</b>							
			<b>3</b>	<b>L03</b>	<b>5</b>	<b>11P</b>	<b>15</b>	<b>26</b>	<b>26D</b>	<b>514</b>
	721KNL UL	Passage UL (3 Hr.)	\$59.10			\$64.10	\$64.10		\$59.10	\$67.10
	733KNL UL	Privacy UL (3 Hr.)	\$63.10			\$68.10	\$68.10		\$63.10	\$71.10
	756KNL UL	Keyed Entry UL (3 Hr.)					\$93.80		\$88.80	
	756KNL SMT UL	Keyed Entry UL (3 Hr.)	\$88.80			\$93.80	\$93.80		\$88.80	\$96.80
	781KNL UL	Storeroom UL (3 Hr.)					\$96.80		\$91.80	
	781KNL SMT UL	Storeroom UL (3 Hr.)	\$91.80			\$96.80	\$96.80		\$91.80	\$99.80
	788KNL	Half Dummy	\$29.60			\$32.10	\$32.10		\$29.60	\$32.70

## GRADE 3 LEVERS

<b>Carson™</b>	<b>Model</b>	<b>Function</b>	<b>Finish</b>							
			<b>3</b>	<b>L03</b>	<b>5</b>	<b>11P</b>	<b>15</b>	<b>26</b>	<b>26D</b>	<b>514</b>
	407CNL	Passage UL (3 Hr.)	\$42.70			\$47.70	\$47.70		\$42.70	\$50.70
	408CNL	Privacy UL (3 Hr.)	\$46.70			\$51.70	\$51.70		\$46.70	\$54.70
	438CNL SMT UL	Entry UL (3 Hr.)	\$72.40			\$77.40	\$77.40		\$72.40	\$80.40
	439CNL SMT UL	Storeroom UL (3 Hr.)	\$75.40			\$80.40	\$80.40		\$75.40	\$83.40
	488CNL	Half Dummy	\$21.40			\$23.90	\$23.90		\$21.40	\$24.40

<b>Palmina</b>	<b>Model</b>	<b>Function</b>	<b>Finish</b>						
			<b>3</b>	<b>L03</b>	<b>5</b>	<b>11P</b>	<b>15</b>	<b>26</b>	<b>26D</b>
	407PLL	Passage UL (3 Hr.)					\$47.70		\$42.70
	408PLL	Bed/Bath UL (3 Hr.)					\$51.70		\$46.70
	438PLL SMT	Entry SMT UL (3 Hr.)					\$77.40		\$72.40
	488PLL	Half Dummy					\$23.90		\$21.40

\*For 438PLL & 488PLL Function must specify RH or LH when ordering

**INTERCONNECT**

<b>Door Prep</b>	Crossbore 2-1/8" Edge Bore 1" 5-1/2 center-to-center only.
<b>Backset</b>	Must specify backset 2-3/8" or 2-3/4".
<b>Door Thickness</b>	1-3/8" - 2-1/4"
<b>Cylinder</b>	SmartKey Security or Pin & Tumbler.
<b>Faceplates</b>	Available in round corner or square corner
<b>Strikes</b>	Depends on if a round corner or square corner latch is ordered.  Round corner latch orders come with the following: 2.74" x 1.115" round corner deadbolt strike, 2.25" x 1.75" 5303 round corner full lip deadbolt strike (grade 3 when used) and 1" x 2-1/4" round corner full lip lever strike.  Square corner latch orders come with the following: 2.74" x 1.115" square corner deadbolt strike, 2.25" x 1.75" 5303 square corner full lip deadbolt strike (grade 3 when used), 1" x 2-1/4" square corner full lip lever strike, and square corner T-strike.
<b>Door Handing</b>	508 - reversible.
<b>ANSI/BHMA</b>	Grade 2 Certified
<b>ADA</b>	Lever options are in compliance with the American National Standards Institute (ANSI A117.1) and the Americans with Disabilities Act (ADA).
<b>UL</b>	Meets UL 3 hour fire rating for all functions.

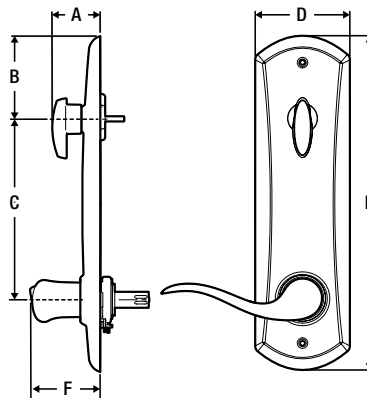

Design	A	B	C	D	E	F
Kingston and Tustin	1 7/16"	2 15/32"	5 1/2"	2 25/64"	10"	2 31/32"

**CONTEMPORARY INTERCONNECT**

<b>Door Prep</b>	2-1/8" diameter face hole & 1" diameter latch hole.
<b>Backset</b>	Must specify backset 2-3/8" or 2-3/4".
<b>Door Thickness</b>	1-3/8" - 1-3/4" automatic adjustment.
<b>Cylinder</b>	SmartKey Security
<b>Faceplates</b>	Available in round corner or square corner
<b>Strikes</b>	Depends on if a round corner or square corner latch is ordered.  Round corner latch orders come with the following: 2.74" x 1.115" round corner deadbolt strike, 2.25" x 1.75" 5303 round corner full lip deadbolt strike (grade 3 when used) and 1" x 2-1/4" round corner full lip lever strike.  Square corner latch orders come with the following: 2.74" x 1.115" square corner deadbolt strike, 2.25" x 1.75" 5303 square corner full lip deadbolt strike (grade 3 when used), 1" x 2-1/4" square corner full lip lever strike, and square corner T-strike.
<b>Door Handing</b>	508 - reversible.
<b>ANSI/BHMA</b>	Grade 2 Certified
<b>ADA</b>	Lever options are in compliance with the American National Standards Institute (ANSI A117.1) and the Americans with Disabilities Act (ADA).
<b>UL</b>	Meets 3 hour fire rating.

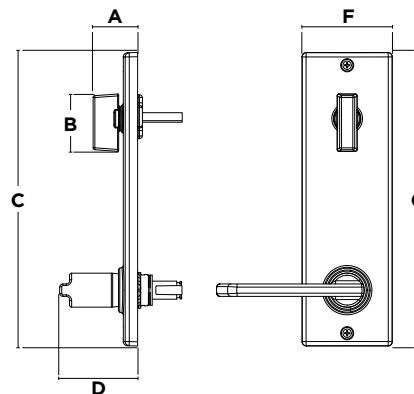

Design	A	B	C	D	E	F
Hali	1 13/32"	1 3/4"	9 3/16"	2 7/16"	5 1/2"	2 27/32"

**KEY CONTROL**

<b>Standard Door Prep</b>	Cross Bore 2-1/8". Edge Bore 1" Latch Face 1" x 2-1/4"
<b>Door Thickness</b>	1-3/4"
<b>Cylinder</b>	2 SmartKey Security™ cylinders: 1 standard Kwikset for users, 1 unique patented keyway for 1-Key Control
<b>Faceplate</b>	1" x 2-1/4" round corner
<b>Strike</b>	2.74" x 1.115" round corner and 2.25" x 1.75" 5303 round corner full lip strike (grade 3 when used) Other strikes are available as service parts.
<b>Bolt</b>	1" throw
<b>ANSI/BHMA</b>	A156.5 Grade 2
<b>ADA</b>	Interior turn piece meets 4.13.9 ADA
<b>UL</b>	Meets UL 3 hour fire rating for UL function. UL Ref# R10923

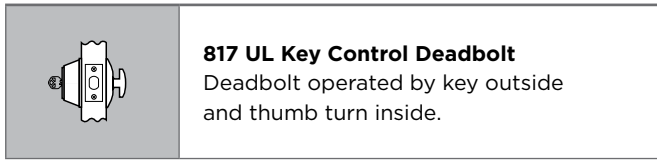

**817 UL Key Control Deadbolt**  
Deadbolt operated by key outside and thumb turn inside.

**Traditional Design**

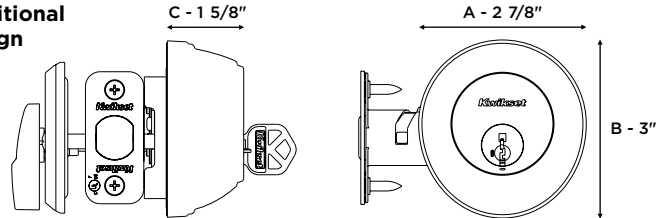

**Contemporary Design**

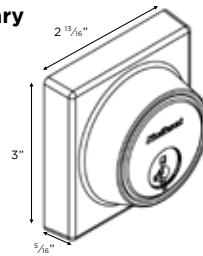

**SMARTCODE 955**

<b>Function</b>	Keyed entry electronic lever
<b>Door Prep</b>	2 1/8" diameter face hole & 1" diameter latch hole
<b>Backset</b>	Adjustable 2 3/8" or 2 3/4"
<b>Door Thickness</b>	1 3/8" - 1 3/4"
<b>Faceplates</b>	1" x 2 1/4" round corner standard
<b>Strikes</b>	Round corner, 4 hole strike, 2 3/4" x 1 1/8"
<b>Latch</b>	Round corner adjustable 2 3/8" x 2 3/4"
<b>Bolt</b>	1/2" throw, dead latch
<b>Door Handing</b>	Reversible
<b>Cylinder</b>	SmartKey Security™

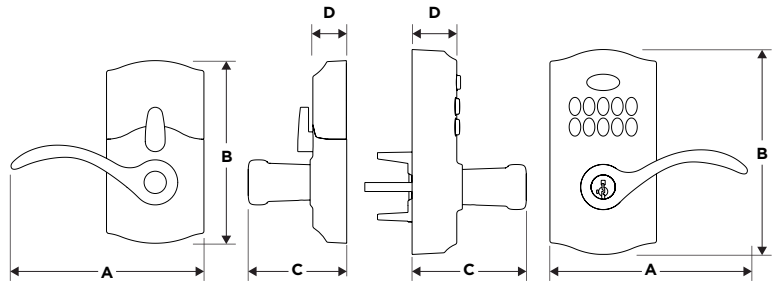

Design	A	B	C	D
Interior	5 5/8" (142.9)	5 5/16" (134.9 mm)	2 7/8" (73 mm)	3 1/32" (24.6 mm)
Exterior	5 3/4" (146 mm)	5 31/32" (151.6 mm)	3 5/16" (84.1 mm)	1 13/32" (35.7 mm)

**KINGSTON LEVER**

ANSI/BHMA	Grade 2 Certified
Door Prep	Crossbore 2-1/8" Edge Bore 1"
Backset	Adjustable to 2-3/8" or 2-3/4".
Door Thickness	1-3/8" - 1-3/4" doors standard
Cylinder	SmartKey Security or Pin & Tumbler.
Latch	Adjustable to 2-3/8" or 2-3/4" round corner.
Strikes	1" x 2-1/4" round corner
Bolt	1/2" throw.
Door Handing	Reversible for right or left-hand doors.
ADA	Lever options are in compliance with the American National Standards Institute (ANSI A117.1) and the Americans with Disabilities Act (ADA).
UL	Meets UL 3 hour fire rating for all functions
Warranty	Lifetime Mechanical, 5 Year Finish
Interior Locking	Push button

**CARSON LEVER**

ANSI/BHMA	Grade 3 Certified
Door Prep	Crossbore 2-1/8" Edge Bore 1"
Backset	Adjustable to 2-3/8" or 2-3/4".
Door Thickness	1-3/8" - 1-3/4" doors standard
Cylinder	SmartKey Security or Pin & Tumbler.
Latch	Adjustable to 2-3/8" or 2-3/4" round corner.
Strikes	1" x 2-1/4" round corner
Bolt	1/2" throw.
Door Handing	Reversible for right or left-hand doors.
ADA	Lever options are in compliance with the American National Standards Institute (ANSI A117.1) and the Americans with Disabilities Act (ADA).
UL	Meets UL 3 hour fire rating for all functions
Warranty	Lifetime Mechanical, 5 Year Finish
Interior Locking	Push button

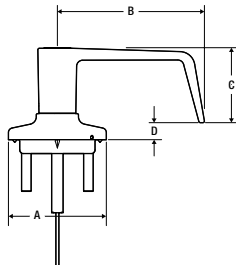

Design	A	B	C	D
Kingston	2.56"	3.84"	1.96"	.44"

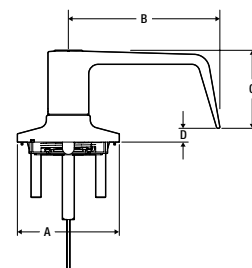

Design	A	B	C	D
Carson	2.56"	3.80"	1.96"	.35"

**PALMINA LEVER**

ANSI/BHMA	Grade 2 Certified
Door Prep	Crossbore 2-1/8" Edge Bore 1"
Backset	Adjustable to 2-3/8" or 2-3/4".
Door Thickness	1-3/8" - 1-3/4" doors standard
Cylinder	SmartKey
Latch	Adjustable to 2-3/8" or 2-3/4" round corner
Strikes	1" x 2-1/4" round corner
Bolt	1/2" throw.
Door Handing	Reversible for right or left-hand doors.
ADA	Lever functions satisfy 4.13.9 ADA requirements
UL	Meets UL 3 hour fire rating for all functions
Warranty	Lifetime Mechanical, 5 Year Finish
Interior Locking	Push button

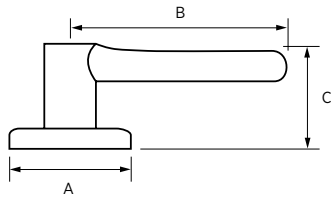

Design	A	B	C
Palmina	2.56"	3.75"	1.96"





POCKET DOOR LOCKS,  
TRIMS & INSTALLATION KIT

**Round Pocket  
Door Lock**



Model	Function											Case
		3	L03	5	11P	15	26	26D	32	514	Qty	
334	Passage				\$42.70	\$42.70		\$42.70		\$42.70	12	
335	Privacy				\$46.80	\$46.80		\$46.80		\$46.80	12	

**Contemporary  
Pocket Door  
Lock**

















Model	Function											Case
		3	L03	5	11P	15	26	26D	32	514	Qty	
334SQT	Passage				\$42.70	\$42.70	\$42.70	\$42.70		\$42.70	12	
335SQT	Privacy				\$46.80	\$46.80	\$46.80	\$46.80		\$46.80	12	







## SERVICE PARTS



LEVERS	EA. QTY	SKU No.	STYLE COMPATIBILITY												List Price					
			3	4	5	15	26	26D	TIP	514	BLK	GLD	SLVR	NO FINISH		TNL	HFL, LSL, MIL, SAL, TPL	KAL, PTH, SEL, TDL	BL, DL, DNL, HYL, LRL	BRNL, CSL, HSL
<b>STRIKES</b>																				
	1	80318				-007	-005	-005	-008	-008										\$4,440
	1	83929				-002	-006	-003	-003	-008	-008									\$10.80
	1	83796	-021			-022	-011	-011	-019	-019										\$10.80
	1	83437	-047			-048	-045	-036	-036	-040	-040									\$10.80
	1	83536	-001			-003	-002	-002	-005	-005										\$10.80
	1	83534	-001			-003	-004	-004	-002	-002										\$10.80
	1	83028	-024			-021	-019	-010	-010	-023	-023									\$10.80
	1	83288												-001						\$10.80
	1	81231												-001						\$10.80
	1	83031	-001			-005	-003	-003	-007	-007										\$10.80
	1	83030	-001			-005	-003	-003	-007	-007										\$10.80
	1	83846				-015	-004	-004	-017	-017										\$14.80
<b>LATCHES</b>																				
	1	83714	-001			-003	-004	-004	-002	-002										\$21.80
	1	81844	-011			-012	-008	-003	-003	-013	-013									\$21.80
	1	83014	-016			-018	-017	-017												\$21.80

LEVERS	EA. QTY	SKU No.	STYLE COMPATIBILITY													List Price						
			3	4	5	15	26	26D	11P	514	BLK	GLD	SLVR	NO FINISH	TNL		HFL, LSL, MIL, SAL, TPL	KAL, PTH, SEL, TDL	BL, DL, DNL, HYL, LRL	BRNL, CSL, HSL		
	1	83712				-002	-003	-003	-001	-001							•		•		\$21.80	
	1	83713				-002	-003	-003	-001	-001							•		•		\$21.80	
* Up to and Included 3HR																						
	1	83710				-001	-002	-002									•		•		\$21.80	
	1	83711				-001	-002	-002									•		•		\$21.80	
** Deadlatch compatible with Entry and Vestibule																						
<b>Cylinders</b>																						
	1	85172															•	•	•	•	•	\$28.80
	1	83279															•	•	•	•	•	\$28.80
	1	83739															•		•			\$25.80
<b>SCREW PACKS: LATCHES AND STRIKES</b>																						
	1	81711	-001	-001	-001	-002	-002	-002	-004	-004							•	•	•	•	•	\$5.80
<b>SCREW PACKS: DUMMY FUNCTION</b>																						
	1	81708	-001			-004	-002	-002	-003	-003							•			•	•	\$8.80
	1	89932				-003	-001	-001	-002	-002							•	•				\$8.80
<b>SCREW PACKS: CHASSIS MOUNTING</b>																						
	1	81835	-001			-005	-002	-002	-006	-006							•			•	•	\$8.80
	1	81706	-005			-006	-002	-002	-007	-007							•			•	•	\$9.80
	1	89930				-003	-001	-001	-002	-002							•	•				\$8.80
	1	89933				-003	-001	-001	-002	-002							•					\$9.80

Style Abbreviations available on page 103

														STYLE COMPATIBILITY								
LEVERS		EA. QTY	SKU No.	3	4	5	15	26	26D	11P	514	BLK	GLD	SLVR	NO FINISH	TNL	HFL, LSL, MIL, SAL, TPL	KAL, PTH, SEL, TDL	BL, DL, DNL, HYL, LRL	BRNL, CSL, HSL	List Price	
	Thick Door Passage Kit (RLEVER 2+)	1	83752	-002			-003	-001	-001	-004	-004						•	•			\$18.80	
<b>PARTS MISC</b>																						
	Set Screw for Passage, Privacy and SMT Entry Interiors	1	83254													-001	•	•	•	•	•	\$3.80
	Set Screw for SMT Entry Exteriors	1	83257													-001	•	•	•	•	•	\$3.80
	Set Screw for P&T Entry Interiors	1	83255													-001				•		\$3.80
	Set Screw for P&T Entry Exteriors	1	83256													-001				•		\$3.80
	Privacy Emergency Tool 100CT	1	81087													-001	•			•	•	\$40.00
	Privacy Emergency Tool	1	81087													-006	•			•	•	\$8.80
	Privacy Emergency Tool	1	83258													-001		•	•			\$7.80













KNOBS	EA. QTY	SKU No.	STYLE COMPATIBILITY																	List Price										
			3	4	5	15	26	26D	11P	514	BLK	GLD	SLVR	NO FINISH	PSK	AYK	A	CN	H		J	L	T	P	AO	CV				
<b>STRIKES</b>																														
	Adjustable Round Circle Strike 500CT	1	83318					-007	-005	-005	-008	-008																		\$4,440
	Round Circle Strike	1	83929					-002	-006	-003	-003	-008	-008																	\$10.80
	Round Corner Full Lip Strike	1	83796	-021				-022	-011	-011	-019	-019																		\$10.80
	Square Corner Full Lip Strike	1	83437	-047				-048	-045	-036	-036	-040	-040																	\$10.80
	Round Corner Adjustable Extended Lip Strike	1	83534	-001				-003	-004	-004	-002	-002																		\$10.80
	T-Strike - Knob/Lever/Gatelatch	1	83028	-024				-021	-019	-010	-010	-023	-023																	\$10.80
	Dust Box for Round & Square Full Lip Strikes (83796/83437)	1	83288											-001																\$10.80
	Dust Box for T-Strike (83028)	1	81231											-001																\$10.80
	ASA Full Lip Strike	1	83846					-015	-004	-004	-017	-017																		\$14.80
<b>LATCHES</b>																														
	Plain Latch 6AL (FD Rated Latch with Sticker)	1	83714	-001				-003	-004	-004	-002	-002																		\$21.80
	Deadlatch 6AL	1	81844	-011				-012	-008	-003	-003	-013	-013																	\$21.80
	Square Corner 5" Deadlatch	1	83014	-016				-018		-017	-017																			\$21.80
<b>CYLINDERS</b>																														
	SMC Cylinder, KD	1	85172											-001	-002	-003														\$28.80
	SMT Cylinder, KD	1	83279											-004	-005	-006														\$28.80
	P&T Cylinder and Cover for Polo, KD	1	83737	-002				-005	-003	-004	-001																			\$25.80

Style Abbreviations available on page 103

KNOBS	EA. QTY	SKU No.	STYLE COMPATIBILITY																List Price								
			3	4	5	15	26	26D	11P	514	BLK	GLD	SLVR	NO FINISH	PSK	AYK	A	CN		H	J	L	T	P	AO	CV	
	1	83733	-002			-005	-003	-004	-006	-001																\$25.80	
	1	83734	-002			-005	-003	-004	-001	-006															\$25.80		
<b>SCREW PACKS: LATCHES AND STRIKES</b>																											
	1	81711	-001	-001	-001	-002	-002	-002	-004	-004																\$5.80	
<b>SCREW PACKS: DUMMY FUNCTION</b>																											
	1	81708	-001			-004	-002	-002	-003	-003																\$8.80	
<b>SCREW PACKS: CHASSIS MOUNTING</b>																											
	1	81835	-001			-005	-002	-002	-006	-006																\$8.80	
	1	81706	-005			-006	-002	-002	-007	-007																\$9.80	
<b>PARTS MISC</b>																											
	1	83254												-001												\$3.80	
	1	83257												-001												\$3.80	
	1	81087												-001												\$40.00	
	1	81087												-006												\$8.80	
	1	85624												-002												\$80.80	



















DEADBOLTS - SECURITY SERIES		EA. QTY	SKU No.	3	4	5	15	26	26D	11P	514	BLK	GLD	SLVR	NO FINISH	660	665	663	664	667	677	817	599	List Price
<b>STRIKES</b>																								
	Deadbolt Round Corner Strike, 1" x 2-1/4"	1	85063	-001			-014	-013	-013	-008	-008						•	•	•		•	•	•	\$10.80
	Deadbolt Square Corner Strike, 1" x 2-1/4"	1	85072	-020			-019	-004	-004	-018	-018						•	•	•		•	•		\$10.80
	Deadbolt Round Corner Strike, 1-1/8" x 2-3/4"	1	85279	-003			-009	-002	-002	-015	-015						•	•	•		•	•		\$10.80
	Deadbolt Square Corner Strike, 1-1/8" x 2-3/4"	1	85278	-001			-020	-021	-021	-019	-019						•	•	•		•	•		\$10.80
	Deadbolt Round Corner Full Lip Strike	1	85303	-001			-018	-016	-016	-017	-017						•	•	•		•			\$10.80
	Deadbolt Square Corner Full Lip Strike	1	84638	-001			-008	-002	-002	-010	-010						•	•	•		•			\$10.80
	Deadbolt T-Strike	1	84632	-001			-005	-002	-002	-007	-007						•	•	•					\$10.80
	Deadbolt Round Corner Strike, 4-Hole Offset, 1-1/4" x 3-5/8"	1	83223	-019			-022	-020	-020	-017	-017											•		\$10.80
	Deadbolt Square Corner Strike, 4-Hole Offset, 1-1/4" x 3-5/8"	1	83222	-002			-029	-005	-005	-027	-027											•		\$10.80
	Gatelatch T-Strike	1	83028	-024			-021	-019	-010	-010	-023	-023											•	\$10.80
	Deadbolt Strike Box - use with 83222/83223	1	81640												-003								•	\$6.80
<b>LATCHES</b>																								
	Deadbolt 5" Latch	1	82730	-001				-002	-002								•	•	•		•			\$21.80
	Gatelatch Deadlatch 2-3/8"	1	83277	-001				-002	-002														•	\$45.80
	Deadbolt 6-Way Adjustable Latch	1	83703				-001	-003	-003	-002	-002						•	•	•		•	•		\$21.80

DEADBOLTS - SECURITY SERIES		EA. QTY	SKU No.	3	4	5	15	26	26D	11P	514	BLK	GLD	SLVR	NO FINISH	660	665	663	664	667	677	817	599	List Price
	3HR UL Deadbolt Square Corner Adjustable Latch	1	83704	-001			-003	-004	-004	-002	-002												•	\$21.80
	3HR UL Deadbolt Round Corner Adjustable Latch	1	83705	-001			-003	-004	-004	-002	-002												•	\$21.80
	3HR UL Deadbolt Round Corner Latch 2 3/8"	1	83746				-002	-003	-003	-001	-001							•						\$21.80
	3HR UL Deadbolt Square Corner Latch 2 3/8"	1	83747				-002	-003	-003	-001	-001							•						\$21.80
	3HR UL Deadbolt Round Corner Latch 2 3/4"	1	83748				-002	-003	-003	-001	-001							•						\$21.80
	3HR UL Deadbolt Square Corner Latch 2 3/4"	1	83749				-002	-003	-003	-001	-001							•						\$21.80
	20 Min FD Deadbolt Round Corner Adjustable Latch	1	83755	-001			-002	-003	-003	-004	-004						•	•	•					\$21.80
	20 Min FD Deadbolt Square Corner Adjustable Latch	1	83756	-001			-002	-003	-003	-004	-004						•	•	•					\$21.80
<b>CYLINDERS - PIN &amp; TUMBLER</b>																								
	Deadbolt Exterior Single Cylinder 5 Pin, KD or Config Cut	1	83735	-001			-002	-004	-005	-006	-003							•						\$25.80
	Interior and Exterior Cylinder 5 Pin, KD	1	83736	-001			-002	-004	-005	-006	-003							•						\$25.80
<b>CYLINDERS - SMT</b>																								
	SMT Exterior Single Cylinder Plug, KD or Config	1	83373																				•	\$28.80
	SMT Exterior Single Cylinder w/Housing, KD	1	83343	-001			-002	-003	-005	-006	-007	-008											•	\$28.80
	SMT Exterior Double Cylinder Plug, KD or Config	1	84301																				•	\$28.80

Style Abbreviations available on page 103

DEADBOLTS - SECURITY SERIES		EA. QTY	SKU No.	3	4	5	15	26	26D	11P	514	BLK	GLD	SLVR	NO FINISH	660	665	663	664	667	677	817	599	List Price	
	SMT Interior Double Cylinder Plug, KD or Config	1	84302										-001	-003	-002		•								\$28.80
	SMT Exterior Double cylinder w/housing, KD	1	84303										-001	-003	-002		•								\$28.80
<b>CYLINDERS - SMC</b>																									
	SMC Exterior Single Cylinder, KD	1	85174										-001	-002	-003		•						•		\$28.80
	SMC Exterior Double Cylinder, KD	1	85170										-001	-002	-003		•								\$28.80
	SMC Interior Double Cylinder, KD	1	85171										-001	-002	-003		•								\$28.80
<b>SCREWS</b>																									
	Deadbolt Single Cylinder Screw Pack	1	86171	-001			-003	-002	-002	-004	-004						•								\$8.80
	Deadbolt Single Cylinder Screw Pack - Thick Door w/ Spindle Extender	1	86129	-001			-007	-006	-006	-008	-008						•								\$9.80
	Deadbolt Double Cylinder Screw Pack	1	86099	-001			-003	-002	-002	-004	-004						•								\$8.80
	Deadbolt Double Cylinder Screw Pack - Thick Door w/ Spindle Extender	1	86130	-001			-008	-006	-006	-009	-009						•								\$18.80
	Deadbolt One-Sided Screw Pack	1	83720				-001	-002	-002									•							\$8.80
	Deadbolt Screw Pack	1	83474	-001			-003	-002	-002	-005	-005												•		\$12.80
	Latch & Strike Screw Pack	1	81711	-001	-001	-001	-002	-002	-002	-004	-004						•	•	•	•	•	•	•	•	\$5.80
	Deadbolt Strike Screws - use with 83222/83223 Strike	1	86356	-004			-008	-006	-006	-007	-007											•			\$8.80

DEADBOLTS - SECURITY SERIES		EA. QTY	SKU No.	3	4	5	15	26	26D	11P	514	BLK	GLD	SLVR	NO FINISH	660	665	663	664	667	677	817	599	List Price	
<b>PARTS - MISC</b>																									
	Key Control Deadbolt Thin Door Kit	1	83397	-001			-002		-004	-003	-003													•	\$18.80
	Key Control Deadbolt Cylinder Cover	1	83389	-001			-002	-002	-002	-005	-005													•	\$8.80

DEADBOLTS - SIGNATURE SERIES		EA. QTY	SKU No.	3	4	5	15	26	26D	11P	514	BLK	GLD	SLVR	NO FINISH	158	159	258	780	785	782	980	985	982	List Price		
<b>STRIKES</b>																											
	Deadbolt Round Corner Strike, 1" x 2-1/4"	1	85063	-001			-014	-013	-013	-008	-008															\$10.80	
	Deadbolt Square Corner Strike, 1" x 2-1/4"	1	85072	-020			-019	-004	-004	-018	-018															\$10.80	
	Deadbolt Round Corner Strike, 1-1/8" x 2-3/4"	1	85279	-003			-009	-002	-002	-015	-015															\$10.80	
	Deadbolt Square Corner Strike, 1-1/8" x 2-3/4"	1	85278	-001			-020	-021	-021	-019	-019															\$10.80	
	Deadbolt Round Corner Full Lip Strike	1	85303	-001			-018	-016	-016	-017	-017															\$10.80	
	Deadbolt Square Corner Full Lip Strike	1	84638	-001			-008	-002	-002	-010	-010															\$10.80	
	Deadbolt T-Strike	1	84632	-001			-005	-002	-002	-007	-007															\$10.80	
	Deadbolt Round Corner Strike, 4-Hole Offset, 1-1/4" x 3-5/8"	1	83223	-019			-022	-020	-020	-017	-017															\$10.80	
	Deadbolt Square Corner Strike, 4-Hole Offset, 1-1/4" x 3-5/8"	1	83222	-002			-029	-005	-005	-027	-027															\$10.80	
	Deadbolt Round Corner Strike, 4-Hole, 1-1/8" x 2-3/4"	1	820050				-005	-003	-003	-004	-004															\$10.80	
	Deadbolt Square Corner Strike, 4-Hole, 1-1/8" x 2-3/4"	1	820049				-005	-003	-003	-007	-007															\$10.80	
	Deadbolt Strike Box - use with 83222/83223	1	81640												-003											\$6.80	
<b>LATCHES</b>																											
	Deadbolt 6 Way Adj Latch	1	83703				-001	-003	-003	-002	-002																
	Deadbolt 6 Way Adj Latch (FD Rated with Label)	1	83707				-001	-003	-003	-002	-002															\$21.80	
	Deadbolt 5" Latch	1	82730	-001			-002	-002																		\$21.80	

DEADBOLTS - SIGNATURE SERIES		EA. QTY	SKU No.	3	4	5	15	26	26D	11P	514	BLK	GLD	SLVR	NO FINISH	158	159	258	780	785	782	980	985	982	List Price		
	3HR UL Deadbolt Square Corner Adjustable Latch	1	83704	-001			-003	-004	-004	-002	-002					•	•				•		•		\$21.80		
	3HR UL Deadbolt Round Corner Adjustable Latch	1	83705	-001			-003	-004	-004	-002	-002					•	•				•		•		\$21.80		
<b>CYLINDERS - PIN &amp; TUMBLER</b>																											
	Deadbolt Exterior Cylinder 6 Pin, KD or Config Cut	1	83738	-002			-001	-003	-004		-005										•	•				\$25.80	
<b>CYLINDERS - SMT</b>																											
	SMT Exterior Single Cylinder Plug, KD or Config Cut	1	83373											-007	-005	-008	•		•		•	•		•		\$28.80	
	SMT Exterior Single Cylinder Plug, KD	1	83025											-003	-002	-001			•							\$28.80	
	SMT Exterior Single Cylinder w/Housing, KD	1	83326	-013			-007	-005	-006	-004	-012						•		•		•	•		•		\$57.60	
	SMT Exterior Double Cylinder Plug, KD or Config Cut	1	84301											-001	-003	-002			•		•		•			\$28.80	
	SMT Interior Double Cylinder Plug, KD or Config Cut	1	84302											-001	-003	-002			•				•			\$28.80	
	SMT Exterior Double Cylinder w/Housing, KD		84303											-001	-003	-002			•		•		•			\$28.80	
<b>CYLINDERS - SMC</b>																											
	SMC Exterior Single Cylinder, KD	1	85174											-001	-002	-003	•		•		•	•		•		\$28.80	
	SMC Exterior Single Cylinder, KD	1	85173											-001	-002	-003			•							\$28.80	
	SMC Exterior Double Cylinder, KD	1	85170											-001	-002	-003			•		•		•			\$28.80	
	SMC Interior Double Cylinder, KD	1	85171											-001	-002	-003			•		•		•			\$28.80	

Style Abbreviations available on page 103

DEADBOLTS - SIGNATURE SERIES		EA. QTY	SKU No.	3	4	5	15	26	26D	11P	514	BLK	GLD	SLVR	NO FINISH	158	159	258	780	785	782	980	985	982	List Price		
<b>SCREWS - MPP</b>																											
	Deadbolt Screw Pack	1	81247	-007				-006	-001	-001	-008	-008															\$8.80
	Deadbolt Screw Pack for Thick Door w/ Spindle Extender	1	81691	-006				-007	-002	-002	-005	-005															\$9.80
	Deadbolt Thick Door Extension Kit w/ Spindle and Screw Extenders	1	84221												-001												\$18.80
	Deadbolt Screw Pack	1	83474	-001				-003	-002	-002	-005	-005															\$12.80
	Deadbolt Mounting Screws	1	83015					-002	-001	-001	-003	-003															\$8.80
	Deadbolt Mounting Screws for Thin Door	1	83017					-002	-001	-001	-003	-003															\$8.80
	Deadbolt Mounting Screws for Thick Door	1	83022					-002	-001	-001	-003	-003															\$9.80
	Deadbolt Mounting Screws	1	820285					-002	-001	-001	-003	-003															\$8.80
	Deadbolt Mounting Screws for Thick Door w/ Spindle Extender	1	820289					-002	-001	-001	-003	-003															\$9.80
	Deadbolt Mounting Screws	1	820286					-002	-001	-001	-003	-003															\$12.80
	Deadbolt Mounting Screws for Thick Door w/ Spindle Extender	1	820290					-002	-001	-001	-003	-003															\$9.80
<b>SCREW - LATCHES AND STRIKES</b>																											
	Latch & Strike Screw Pack	1	81711	-001	-001	-001	-002	-002	-002	-004	-004																\$5.80
	Deadbolt Strike Screws - use with 83222/83223 Strike	1	86356	-004				-008	-006	-006	-007	-007															\$8.80

														STYLE COMPATIBILITY				List Price	
HANDLESETS	EA. QTY	SKU No.	3	4	5	15	26	26D	11P	514	BLK	GLD	SLVR	NO FINISH	AMD, BW, DA, HYH	ADH, AN AT, AUH, AVH, CE, HE, SE, TVH	PGH PTH, SCE, VNH		
<b>HANDLESET COMPONENTS</b>																			
	Handset Mechanism Thick Door	1	83669												-001	•	•	•	\$30.80
<b>STRIKE - DEADBOLT</b>																			
	Deadbolt Round Corner Strike, 4-Hole Offset, 1-1/4" x 3-5/8"	1	83223	-019			-022	-020	-020	-017	-017					•	•	•	\$10.80
	Deadbolt Square Corner Strike, 4-Hole Offset, 1-1/4" x 3-5/8"	1	83222	-002			-029	-005	-005	-027	-027					•	•	•	\$10.80
	Deadbolt Round Corner Strike, 1-1/8" x 2-3/4"	1	85279	-003			-009	-002	-002	-015	-015					•		•	\$10.80
	Deadbolt Square Corner Strike, 1-1/8" x 2-3/4"	1	85278	-001			-018	-016	-016	-017	-017					•			\$10.80
	Deadbolt Round Corner Full Lip Strike	1	85303	-001			-018	-016	-016	-017	-017					•	•	•	\$10.80
	Deadbolt Square Corner Full Lip Strike	1	84638	-001			-008	-002	-002	-010	-010					•	•	•	\$10.80
	Deadbolt Round Corner Strike, 1" x 2-1/4"	1	85063	-001			-014	-013	-013	-008	-008					•	•	•	\$10.80
	Deadbolt Square Corner Strike, 1" x 2-1/4"	1	85072	-020			-019	-004	-004	-018	-018					•	•	•	\$10.80
	Deadbolt Square Corner Strike, 4-Hole, 1-1/8" x 2-3/4" (Grade 1)	1	820049				-005	-003	-003	-007	-007							•	\$10.80
	Deadbolt Round Corner Strike, 4-Hole, 1-1/8" x 2-3/4" (Grade 1)	1	820050				-005	-003	-003	-004	-004							•	\$10.80
	Deadbolt T-Strike	1	84632	-001			-005	-002	-002	-007	-007					•			\$10.80
<b>STRIKE - KNOB/LEVER</b>																			
	Knob/Lever Round Corner Full Lip Strike	1	83796	-021			-022	-011	-011	-019	-019					•	•	•	\$10.80
	Knob/Lever Round Corner Adjustable Extended Lip Strike	1	83534	-001			-003	-004	-004	-002	-002					•			\$10.80
	Knob/Lever Round Corner Extended Lip Strike	1	83536	-001			-003	-002	-002	-005	-005							•	\$10.80

Style Abbreviations available on page 103



															STYLE COMPATIBILITY			List Price
HANDLESETS	EA. QTY	SKU No.	3	4	5	15	26	26D	11P	514	BLK	GLD	SLVR	NO FINISH	AMD, BW, DA, HYH	ADH, AN AT, AUH, AVH, CE, HE, SE, TVH	PGH PTH, SCE, VNH	
	1	83437	-047		-048	-045	-036	-036	-040	-040					•	•	•	\$10.80
	1	83028	-024		-021	-019	-010	-023							•	•	•	\$10.80
	1	83846				-015	-004	-017								•	•	\$14.80
<b>SCREWS - LATCH &amp; STRIKE</b>																		
	1	86356	-004			-008	-006	-006	-007	-007						•		\$8.80
	1	81711	-001	-001	-001	-002	-002	-002	-004	-004					•	•	•	\$5.80
<b>LATCHES - DEADBOLT</b>																		
	1	83703				-001	-003	-003	-002	-002						•		\$21.80
	1	83023				-001	-002	-002	-004	-004							•	\$30.80
	1	83347	-008												•			\$21.80
	1	81306												-003	•			\$21.80
<b>CYLINDERS</b>																		
	1	83326	-013			-007	-005	-006	-004	-012						•		\$57.60
	1	83025									-003	-002	-001				•	\$28.80
	1	83343	-001		-002	-003	-005	-006	-007	-008					•			\$28.80
	1	85173									-001	-002	-003				•	\$28.80
	1	83735	-001		-002	-004	-005	-006	-003						•			\$25.80



Style Abbreviations available on page 103

1666075-01/24



HANDLESETS	EA. QTY	SKU No.	3	4	5	15	26	26D	TIP	514	BLK	GLD	SLVR	NO FINISH	STYLE COMPATIBILITY			List Price
															AMD, BW, DA, HYH	ADH, AN AT, AUH, AVH, CE, HE, SE, TVH	PGH PTH, SCE, VNH	
SMC Cylinder with Housing, KD	1	83745				-002		-003	-001	-004						•		\$28.80
SMC Cylinder Plug, KD	1	85174									-001	-002	-003			•		\$28.80
<b>DEADBOLT MOUNTING SCREWS</b>																		
Standard Door Mounting Screws	1	84235				-001	-003	-003	-002	-002						•		\$8.80
Standard Door Mounting Screws	1	83015				-002	-001	-001	-003	-003							•	\$8.80
Thick Door Chassis Screws	1	81248				-004	-003	-003	-005	-005							•	\$9.80
Thick Door Chassis Screws	1	83022				-002	-001	-001	-003	-003							•	\$9.80
<b>HANDLESET BOTTOM CONNECTION</b>																		
Bottom Screw and Washer - Austin Only	1	84307													-001		•	\$7.60
Bottom Screw and Washer - HE, SE, ADH, AVH, TVH	1	82213													-002		•	\$7.60
Bottom Screw and Washer Thick Door - HE, SE, ADH, AVH, TVH	1	83724													-001		•	\$7.60
Door Screw Exterior - AMD, AN, BW, CE, DA, HYH	1	83721				-002	-003	-003	-001	-001						•	•	\$8.80
Door Screw Exterior Thick Door - AMD, AN, BW, CE, DA, HYH	1	88376				-004	-005	-005	-003	-003						•	•	\$9.80
Sex Nut Interior - AMD, AN, BW, CE, DA, HYH	1	88410				-007	-008	-008	-006	-006						•	•	\$8.80
Bottom Screw and Washer - 818 Handlesets	1	83004													-001		•	\$7.60
Bottom Screw and Washer Thick Door - 818 Handlesets	1	81861													-001		•	\$9.80













Style Abbreviations available on page 103

INTERCONNECT		EA. QTY	SKU No.	3	5	15	26	26D	11P	514	BLK	GLD	SLVR	NO FINISH	508 P&T	508 SMT	List Price
<b>STRIKES - DEADBOLT</b>																	
	Deadbolt Square Corner No Logo Metal Door Strike	1	85278	-001		-020	-021	-021	-019	-019					•	•	\$10.80
	Deadbolt T Strike	1	84632	-001		-005	-002	-002	-007	-007					•	•	\$10.80
	Deadbolt Round Corner Strike, 1-1/8" x 2-3/4"	1	85279	-003		-009	-002	-002	-015	-015					•	•	\$10.80
	Deadbolt Square Corner Strike, 1-1/8" x 2-3/4"	1	85278	-001		-020	-021	-021	-019	-019					•	•	\$10.80
	Deadbolt Round Corner Strike, 4-Hole Offset, 1-1/4" x 3-5/8"	1	83223	-019		-022	-020	-020	-017	-017					•	•	\$10.80
	Deadbolt Square Corner Strike, 4-Hole Offset, 1-1/4" x 3-5/8"	1	83222	-002		-029	-005	-005	-027	-027					•	•	\$10.80
<b>STRIKES - LEVER</b>																	
	Interconnect UL Strike Box	1	83288											-001	•	•	\$10.80
	Interconnect ASA 1-1/4" Lip Strike	1	83846			-015	-004	-004	-017	-017					•	•	\$14.80
	Interconnect T-Strike	1	83028	-024	-021	-019	-010	-010	-023	-023					•	•	\$10.80
	Interconnect Round Corner UL Full Lip Strike	1	83031	-001		-005	-003	-003	-007	-007					•	•	\$10.80
<b>LATCH - LEVER</b>																	
	3Hr UL Plain Latch Round Corner Vestibule 2-3/8"	1	84262			-001	-003	-003	-002	-002					•	•	\$21.80
	3Hr UL Plain Latch Round Corner Vestibule 2-3/4"	1	84263			-001	-003	-003	-002	-002					•	•	\$21.80
	3Hr UL Plain Latch Square Corner Vestibule 2-3/8"	1	83753			-001	-002	-002	-003	-003					•	•	\$21.80
	3Hr UL Plain Latch Square Corner Vestibule 2-3/4"	1	83754			-001	-002	-002	-003	-003					•	•	\$21.80
<b>LATCH - DEADBOLT</b>																	
	3HR UL Deadbolt Square Corner Adjustable Latch	1	83704	-001		-003	-004	-004	-002	-002					•	•	\$21.80
	3HR UL Deadbolt Round Corner Adjustable Latch	1	83705	-001		-003	-004	-004	-002	-002					•	•	\$21.80

INTERCONNECT		EA. QTY	SKU No.	3	5	15	26	26D	11P	514	BLK	GLD	SLVR	NO FINISH	508 P&T	508 SMT	List Price	
<b>CYLINDERS</b>																		
	KCDB Cylinder with Housing, KD	1	83744			-002	-003	-004	-001	-005							•	\$57.60
	SMT Exterior Cylinder with Housing, KD	1	83326	-013		-007	-005	-006	-004	-012							•	\$57.60
	SMC Cylinder Plug, KD	1	85174								-001	-002	-003				•	\$28.80
<b>SCREWS - DEADBOLT</b>																		
	Interconnect Screw Pack - KCDB	1	83728			-002	-003	-003	-001	-001							•	\$9.80
	Interconnect Screw Pack - 780 deadbolt	1	83722			-002	-003	-003	-001	-001							•	\$8.80





PUSH BUTTON LEVER		EA. QTY	SKU No.	3	5	15	26	26D	514	BLK	GLD	SLVR	NO FINISH	407	408	438PT	438SMT	439PT	439SMT	List Price		
<b>STRIKES</b>																						
	Knob/Lever Round Corner Full Lip Strike - 3HR UL	1	83031	-001		-005	-003	-003	-007						•	•	•	•	•	•	\$10.80	
	Knob/Lever Square Corner Full Lip Strike - 3HR UL	1	83030	-001		-005	-003	-003	-007						•	•	•	•	•	•	\$10.80	
	ASA 1-1/4" Strike	1	83846			-015	-004	-004	-017						•	•	•	•	•	•	\$14.80	
	T-Strike - Knob/Lever/Gatelatch	1	83028	-024	-021	-019	-010	-010	-023						•	•	•	•	•	•	\$10.80	
	Knob/Lever Round Corner Full Lip Strike	1	83796	-021		-022	-011	-011	-019									•		•	\$10.80	
	Knob/Lever Square Corner Full Lip Strike	1	83437	-047	-048	-045	-036	-036	-040									•		•	\$10.80	
	"Dust Box for Knob/Lever Round & Square Full Lip Strikes (83796/83437)"	1	83288											-001					•		\$10.80	
	Dust Box for Knob/Lever T-Strike (83028)	1	81231											-001	•	•	•	•	•	•	\$10.80	
<b>PLAIN LATCH</b>																						
	Square Corner Adj Plain Latch 3HR UL	1	83520	-001		-003	-004	-004	-002						•	•					\$21.80	
	Round Corner Adj Plain Latch 3HR UL	1	83521	-001		-003	-004	-004	-002						•	•					\$21.80	
<b>DEAD LATCH</b>																						
	Square Corner Adj Deadlatch UL 3hr	1	83517	-001		-003	-004	-004	-002									•	•	•	•	\$21.80
	Round Corner Adj Deadlatch UL 3hr	1	83518	-001		-003	-004	-004	-002									•	•	•	•	\$21.80

PUSH BUTTON LEVER		EA. QTY	SKU No.	3	5	15	26	26D	514	BLK	GLD	SLVR	NO FINISH	407	408	438PT	438SMT	439PT	439SMT	List Price		
<b>CYLINDER: SMT</b>																						
	SMT Knob & Lever Cylinder, KD	1	83279							-004	-005	-006							•	•	\$28.80	
	SMC Knob & Lever Cylinder, KD	1	85172							-001	-002	-003								•	•	\$28.80
	SMT Knob & Lever Square Drive Chassis, KD	1	85200							-002	-001	-003								•	•	\$28.80
<b>SCREWS</b>																						
	Light Commercial Screw Pack	1	83524				-003	-004	-004						•	•	•	•	•	•	\$8.80	

PUSH BUTTON LEVER	EA. QTY	SKU No.	3	5	15	26	26D	514	BLK	GLD	SLVR	NO FINISH	STYLE COMPATIBILITY					List Price				
													721	733	756PT	756SMT	781PT		781SMT			
<b>STRIKE</b>																						
	1	83031	-001	-005	-003	-003	-007								•	•	•	•	•	•	\$10.80	
	1	83030	-001	-005	-003	-003	-007								•	•	•	•	•	•	\$10.80	
	1	83846		-015	-004	-004	-017								•	•	•	•	•	•	\$14.80	
	1	83028	-024	-021	-019	-010	-010	-023							•	•	•	•	•	•	\$10.80	
	1	83796	-021	-022	-011	-011	-019								•	•		•			\$10.80	
	1	83437	-047	-048	-045	-036	-036	-040							•	•		•			\$10.80	
	1	83288										-001		•	•		•				\$10.80	
	1	81231										-001		•	•	•	•			•	\$10.80	
<b>PLAIN LATCH</b>																						
	1	83520	-001	-003	-004	-004	-002								•	•					\$21.80	
	1	83521	-001	-003	-004	-004	-002								•	•					\$21.80	
<b>DEAD LATCH</b>																						
	1	83517	-001	-003	-004	-004	-002										•	•	•	•	\$21.80	
	1	83518	-001	-003	-004	-004	-002										•	•	•	•	\$21.80	
	1	83000		-002	-001	-001	-004														\$21.80	

													STYLE COMPATIBILITY								
PUSH BUTTON LEVER		EA. QTY	SKU No.	3	5	15	26	26D	514	BLK	GLD	SLVR	NO FINISH	721	733	756PT	756SMT	781PT	781SMT	List Price	
<b>CYLINDER: SMT</b>																					
	SMT Knob & Lever Cylinder, KD	1	83279																		\$28.80
	SMC Knob & Lever Cylinder, KD	1	85172																		\$28.80
	SMT Knob & Lever Square Drive Chassis, KD	1	85200																		\$28.80
<b>SCREWS</b>																					
	Light Commercial Screw Pack	1	83523																		\$8.80



KEYS, RE-KEYING KITS & MISC.		CUT TYPE	CONFIGURATION EXPLANATION	EA. QTY	SKU No.	List Price
<b>KEY- KCDB LANDLORD ONLY</b>						
	KCDB "KC" Key Control Key Blank, 10CT	Blank	All loose in a bag	1	83382-001	\$30.00
	KCDB "KC" Cut Key, 4CT	Random Cut	4 keys all KA	1	83383-002	\$25.80
	KCDB "KC" Key Control Key, Specific Cut	Specific Cut	Single key	1	90009-102	\$18.00
<b>SPIN - K BOWS</b>						
	5 Pin, K Bow, 50 CT	Blank	All loose in a box	1	81063-009	\$150.00
	5 Pin, K Bow	Blank	Single key	1	81063-019	\$3.00
	5 Pin, K Bow	Random Cut	4 key rings with 2 cut keys on each that are all KA	1	81057-007	\$42.00
	5 Pin, K Bow	Random Cut	2 key rings with 2 cut keys on each that are all KA	1	81057-005	\$25.80
	5 Pin, K Bow	Random Cut	2 key rings with 2 cut keys on each that are all KA with rekey tool loose	1	83335-002	\$25.80
	5 Pin, K Bow	Random Cut	3 key rings with 2 cut keys on each that are all KA with rekey tool loose	1	83336-001	\$37.80
	5 Pin, K Bow	Specific Cut	Single key	1	90009-101	\$18.00
	5 Pin, K Bow 10CT	Specific Cut	10 keys that are all KA to 23155	1	81063-021	\$60.00
	5 Pin, K Bow, 10CT	Specific Cut	10 keys that are all KA to 42444	1	81063-022	\$60.00
	5 Pin, K Bow, 10CT	Specific Cut	10 keys that are all KA to 66664	1	81063-023	\$60.00
	5 Pin, K Bow, 10CT	Specific Cut	10 keys that are all KA to 77667	1	81063-024	\$60.00
	5 Pin, K Bow, 10CT	Specific Cut	10 keys that are all KA to 65466	1	81063-025	\$60.00
	5 Pin, K Bow, 10CT	Specific Cut	10 keys that are all KA to 65556	1	81063-026	\$60.00
	5 Pin, K Bow, 10CT	Specific Cut	10 keys that are all KA to 55655	1	81063-027	\$60.00
	5 Pin, K Bow, 10CT	Specific Cut	10 keys that are all KA to 66556	1	81063-028	\$60.00

Style Abbreviations available on page 103

1666075-01/24

















KEYS, RE-KEYING KITS & MISC.		CUT TYPE	CONFIGURATION EXPLANATION	EA. QTY	SKU No.	List Price
	5 Pin, K Bow, 10CT	Specific Cut	10 keys that are all KA to 44644	1	81063-029	\$60.00
	5 Pin, K Bow, 10CT	Specific Cut	10 keys that are all KA to 65656	1	81063-030	\$60.00
	5 Pin, K Bow, 10CT	Specific Cut	10 keys that are all KA to 56656	1	81063-031	\$60.00
	5 Pin, K Bow, 10CT	Specific Cut	10 keys that are all KA to 42222	1	81063-032	\$60.00
	5 Pin, K Bow, 10CT	Specific Cut	10 keys that are all KA to 65665	1	81063-020	\$60.00
	5 Pin, K Bow, 10CT	Specific Cut	10 keys that are all KA to 22226	1	81063-033	\$60.00
	5 Pin, K Bow, 10CT	Specific Cut	10 keys that are all KA to 24444	1	81063-034	\$60.00
	5 Pin, K Bow, 10CT	Specific Cut	10 keys that are all KA to 66555	1	81063-035	\$60.00
	5 Pin, K Bow, 10CT	Specific Cut	10 keys that are all KA to 56665	1	81063-036	\$60.00
	5 Pin, K Bow, 10CT	Specific Cut	10 keys that are all KA to 55666	1	81063-037	\$60.00
	5 Pin, K Bow, 10CT	Specific Cut	10 keys that are all KA to 66656	1	81063-038	\$60.00
	5 Pin, K Bow, 10CT	Specific Cut	10 keys that are all KA to 56556	1	81063-039	\$60.00
	5 Pin, K Bow, 10CT	Specific Cut	10 keys that are all KA to 66766	1	81063-040	\$60.00
	5 Pin, K Bow, 10CT	Specific Cut	10 keys that are all KA to 66646	1	81063-041	\$60.00
	5 Pin, K Bow, 10CT	Specific Cut	10 keys that are all KA to 56566	1	81063-042	\$60.00
	5 Pin, K Bow, 10CT	Specific Cut	10 keys that are all KA to 66566	1	81063-043	\$60.00
	5 Pin, K Bow, 10CT	Specific Cut	10 keys that are all KA to 55665	1	81063-044	\$60.00
	5 Pin, K Bow, 10CT	Specific Cut	10 keys that are all KA to 56555	1	81063-045	\$60.00
	5 Pin, K Bow, 10CT	Specific Cut	10 keys that are all KA to 56655	1	81063-046	\$60.00

Style Abbreviations available on page 103

KEYS, RE-KEYING KITS & MISC.		CUT TYPE	CONFIGURATION EXPLANATION	EA. QTY	SKU No.	List Price
<b>SPIN - BUILDER KEYS</b>						
	5 Pin, Solid Bow, Builders Key, 50CT	Blank	Single key	1	82205-032	\$150.00
	5 Pin, Solid Bow, Builders Key, Specific Cut	Specific Cut	Single key	1	90009-107	\$18.00
	5 Pin, Solid Bow, Builders Key	Any Cut	Single key	1	90009-108	\$18.00
	5 Pin, Solid Bow, Master Key, 50CT	Blank	Single key	1	81210-001	\$6.00
	5 Pin, Solid Bow, Master Key, Specific Cut	Specific Cut	Single key	1	90009-109	\$18.00
	5 Pin, Solid Bow, Master Key	Any Cut	Single key	1	90009-110	\$18.00
	5 Pin, Solid Bow, Grand Master Key	Any Cut	Single key	1	90009-111	\$18.00
<b>SPIN - SMC</b>						
	5 Pin, Solid Bow, SMC, 50CT	Blank	All loose in a box	1	85178-001	\$150.00
	5 Pin, Solid Bow, SMC	Random Cut	4 keys all KA	1	85175-002	\$25.80
	5 Pin, Solid Bow, SMC	Specific Cut	Single key	1	90009-118	\$18.00
	5 Pin, Solid Bow, KCDB Control Key, 50CT	Blank	All loose in a box	1	85182-001	\$150.00
	5 Pin, Solid Bow, KCDB Control Key	Specific Cut	Single key	1	90009-117	\$18.00
<b>6PIN</b>						
	6 Pin, K Bow, Nickel Plated, Blank, 50CT	Blank	All loose in a box	1	81208-001	\$150.00
	6 Pin, K Bow, Nickel Plated, Specific Cut	Specific Cut	Single key	1	90009-104	\$18.00
	6 Pin, K Bow, Nickel Plated	Any Cut	Single key	1	90009-119	\$18.00
	6 Pin, Solid Bow, Do Not Duplicate, Blank, 50CT	Blank	All loose in a box	1	81693-001	\$150.00

















KEYS, RE-KEYING KITS & MISC.		CUT TYPE	CONFIGURATION EXPLANATION	EA. QTY	SKU No.	List Price
	6 Pin, Solid Bow, Do Not Duplicate, Specific Cut	Specific Cut	Single key	1	90009-105	\$18.00
	6 Pin, Solid Bow, Do Not Duplicate, Any Cut	Any Cut	Single key	1	90009-120	\$18.00
	6 Pin, Front Removable Cyl, Control Key, Blank, 50CT	Blank	All loose in a box	1	87615-001	\$92.20
	6 Pin, Front Removable Cyl, Control Key, Specific Cut	Specific Cut	Single key	1	90009-106	\$18.00
	6 Pin, Solid Bow, PK	Specific Cut	Single key	1	90009-112	\$18.00
	6 Pin, Solid Bow, Any	Any Cut	Single key	1	90009-113	\$18.00
	6 Pin, Solid Bow, Master Key Config	Specific Cut	Single key	1	90009-114	\$18.00
	6 Pin, Solid Bow, Master Key	Any Cut	Single key	1	90009-115	\$18.00
	6 Pin, Solid Bow, Grand Master Key	Any Cut	Single key	1	90009-116	\$18.00

Style Abbreviations available on page 103



KEYS, RE-KEYING KITS & MISC.		EA. QTY	SKU No.	List Price
<b>MISCELLANEOUS PARTS</b>				
	Knob Plug Retainer Clip	1	84345-001	\$4.80
	Spring for Control Lug Locking Bar, 100CT	1	87652-001	\$20.80
	Deadbolt Control Lug Locking Bar	1	87809-001	\$6.80
	Deadbolt Plug Retainer Clip	1	84215-001	\$4.80
	PK/Construction Balls, 100CT	1	82208-001	\$20.80
	5 Pin Spring Cover, 50CT	1	85757-001	\$40.00
	Tumbler Spring, 100CT	1	81777-001	\$20.80
	6 Pin Spring Cover	1	83561-001	\$4.80
	Cylinder Removal Tool	1	81467-003	\$8.80
	Key Gauge	1	80049-001	\$16.80
<b>P&amp;T KEYING KIT 236</b>				
	236 P&T Builder Keying Kit	1	92360-001	\$420.80
	#3 Bottom Pin Silver .218", 100CT	1	83103-001	\$20.80
	#2 Bottom Pin Purple .195", 100CT	1	83101-001	\$20.80
	#1 Bottom Pin Gold .172", 100CT	1	83100-001	\$20.80
	#6 Bottom Pin Gold .287", 100CT	1	83107-001	\$20.80
	#5 Bottom Pin Red .264", 100CT	1	83106-001	\$20.80
	#4 Bottom Pin Green .241", 100CT	1	83105-001	\$20.80
	#6 Master Pin Gold .138", 100CT	1	83125-001	\$20.80

Style Abbreviations available on page 103

1666075-01/24

KEYS, RE-KEYING KITS & MISC.		EA. QTY	SKU No.	List Price
	#5 Master Pin Red .115", 100CT	1	83114-001	\$20.80
	#4 Master Pin Green .092", 100CT	1	83113-001	\$20.80
	#3 Master Pin Silver .069", 100CT	1	83112-001	\$20.80
	#2 Master Pin Purple .046", 100CT	1	83110-001	\$20.80
	#1 Master Pin Gold .023", 100CT	1	83108-001	\$20.80
	Regular Top Pin Gold .180", 100CT	1	81858-001	\$20.80
	PK Top Pin Red .160", 100CT	1	83117-001	\$20.80
	Plug Follower	1	80152-001	\$16.80
<b>LEARN TOOL</b>				
	Reset Cradle SMT	1	83260-001	\$64.20
	Reset Cradle SMC	1	85181-001	\$28.80
	Learn Tool	1	83282-003	\$7.80
<b>ADDITIONAL ITEMS</b>				
	3103-21 BRS PIN BTM .218 LVR, 100CT	1	83103-001	\$20.80
	3101-21 BRS PIN BTM .195 PRPL, 100CT	1	83101-001	\$20.80
	3105-21 BRS PIN BTM .241 GRN, 100CT	1	83105-001	\$20.80
	3100-21 BRS PIN BTM .172 NTRL, 100CT	1	83100-001	\$20.80
	3106-21 BRS PIN BTM .264 RED, 100CT	1	83106-001	\$20.80
	3107-21 BRS PIN BTM .287 NTRL, 100CT	1	83107-001	\$20.80
	12980 BRS PIN TOP.160 RED, 100CT	1	80369-001	\$40.00

Style Abbreviations available on page 103

KEYS, RE-KEYING KITS & MISC.		EA. QTY	SKU No.	List Price
	12981 BRS PIN TOP .180, 100CT	1	80370-001	\$40.00
	10842 LCK BAR TTN L/S	1	87619-001	\$7.80
	Finishing Ring	1	83621-001	\$18.40

Electronic Service Parts		SKU No.	L03	5	15	11P	26	15/26	11P/514	690/11P	690	514	NA	List Price
	909, 911 & 912 Top Battery Holder	83307											•	\$1.90
	913, 914, 915, 916, 919 and 953 Battery Pack without Pull Tab (for use with 83580)	83581											•	\$1.90
	888, 938, 939, 942, and HC620 Battery Pack with Pull Tab (For use with: 83813/83814)	83502											•	\$1.90
	938 Halo Exterior Keypad	85133			•				•					\$57.56
	939 Halo Exterior Touchscreen	85134			•		•		•					\$113.01
	942 Aura Exterior Keypad	85135			•				•					\$49.70
	942 Aura Keypad Interior Chassis	85140											•	\$118.30
	938 Halo Keypad Interior Chassis	85138											•	\$180.57
	939 Halo Touchscreen Interior Chassis	85139											•	\$179.54
	Electronics Deadbolt Adapter Ring	83583											•	\$3.05
	Tapered Deadbolt, RC, 2-Way	83187	•		•				•		•			\$5.00
	913, 914, 915, 916, 919, 938, 939, 942, 953, 954, and 959 Interior Mounting Plate	85137											•	\$5.45
	HC620 Interior Mounting Plate	83154											•	\$5.45
	909 TRL Top Cover	83306	•		•				•					\$12.60
	917 HFL Interior Battery Cover	85143											•	\$4.50
	917, 955 TNL Interior Battery Cover	85145											•	\$4.50



Electronic Service Parts	SKU No.	L03	5	15	11P	26	15/26	11P/514	690/11P	690	514	NA	List Price
 938, 939, and 942 Interior Cover	85141			•		•		•					\$32.10
 Interior Cover, CNT (For use with: Battery Pack with Pull Tab 83502)	83814			•				•					\$32.10
 Interior Cover, TRL (For use with: Battery Pack with Pull Tab 83502)	83813			•				•					\$32.10
 Security Screw for black interior RF Window	85196			•				•					\$0.50
 909 and 910 Interior Cover Screws	80435			•									\$1.00
 913, 914, 915, 916, 919, 938, 939, 942, 953, 954, and 959 Interior Cover Screws (For use with 85137)	83585	•		•				•					\$1.15
HC 620 Interior Cover Screws (For use with 83154)	83137	•		•				•					\$1.15
 913, 914, 915, 916, 938, 939, 942, and HC620 Mounting Screws & Spindle for 2-1/4" Door Thickness	83159											•	\$5.35
 917 & 955 Replacement Mounting Screws with Spindle	85144			•		•		•					\$6.00
 953, 954 Mounting Screws for 1-3/8" Door Thickness	83651											•	\$5.50
 953, 954 Mounting Screws for 2" Door Thickness	83653											•	\$5.35
 2 1/4" Thick Door Kit for 953, 938, 939, 959	83033											•	\$5.35
Electronics tapered deadbolt adjustable drive-in latch (excluding Smart Code 260 and 270)	83186											•	\$5.05
 53709 - 9240 Electronic Deadbolt (5-Pin), with One KW1 Key	84350	•		•				•					\$18.30
 RCAL 9240/9250 Series Electronic Deadbolt	84351	•		•					•				\$12.20

Electronic Service Parts		SKU No.	L03	5	15	11P	26	15/26	11P/514	690/11P	690	514	NA	List Price
	SMT 9270/9260/9250 Electronic Deadbolt Cylinder Only	84242	•					•	•					\$20.00
	9270/9260 Interior Battery Cover	84253											•	\$6.00
	9270/9260 Mounting Plate	84249											•	\$6.00
	9270/9260 Electronic Deadbolt RC Strike and Screws	84271	•		•	•	•						•	\$8.00
	9270/9260/9250 Electronic Deadbolt Thick Door Pack with SMT Cylinder & Keys	84251	•					•	•					\$25.00
	9270/9260 Electronic Deadbolt Mounting Screws	84250											•	\$4.00
	9270/9260 Electronic Deadbolt Interior Mounting Screws	84252											•	\$3.00

KNOBS	
A	Abbey
AO	Aliso
AYK	Arroyo
CV	Cove
H	Hancock
L	Laurel
P	Polo
PSK	Pismo
T	Tylo

KNOBS	
ADL	Ashfield
AUL	Austin
AVL	Avalon
BL	Balboa
BRNL	Breton
CSL	Casey
CNL	Carson
DL	Delta
DNL	Dorian
HFL	Halifax
HRL	Hali
HYL	Henley
KAL	Katella
KNL	Kingston
LRL	Ladera
LSL	Lisbon
MIL	Milan
PLL	Palmina
PTH	Perth
SEL	Sedona
SAL	Singapore
TDL	Trafford
TPL	Tripoli
TNL	Tustin

HANDLESET	
AMD	Amador
AN	Arlington
ADH	Ashfield
AVH	Avalon
BW	Belleview
CE	Chelsea
DA	Dakota
HE	Hawthorne
PGH	Prague
PTH	Prescott
SCE	San Clemente
TVH	Tavaris
VNH	Vancouver

DEADBOLT	
KCDB	Key Control





***Kwikset***



@KwiksetLocks



@Kwikset



@Kwikset



@KwiksetCorp



@Kwikset

**[www.kwikset.com](http://www.kwikset.com)**

19701 DaVinci • Lake Forest, CA • 92610 • 1-800-327-LOCK (5625)

Copyright © 2024 ASSA ABLOY Americas Residential Inc. • KW-1666075\_01/24